

brother

# Operation Manual

## Overlock Machine

Product Code: 884-B20/B21

---

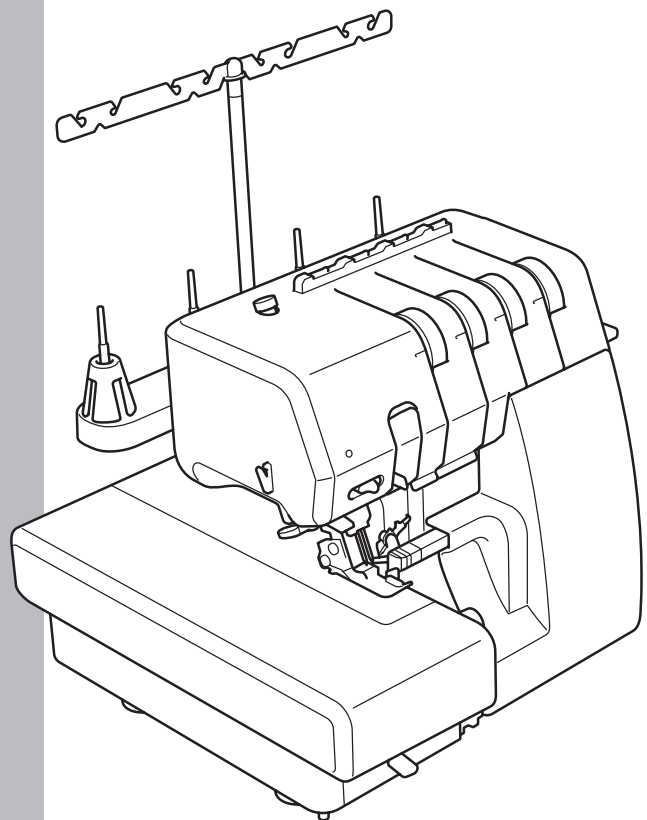

Be sure to read this document before using the machine.  
We recommend that you keep this document nearby for future reference.

## INTRODUCTION

Thank you for purchasing this machine. Before using this machine, carefully read the "IMPORTANT SAFETY INSTRUCTIONS", and then study this manual for the correct operation of the various functions. In addition, after you have finished reading this manual, store it where it can quickly be accessed for future reference.

## IMPORTANT SAFETY INSTRUCTIONS

When using an electrical appliance, basic safety precautions should always be followed, including the following. Please read these safety instructions before attempting to use the machine.

### **⚠ DANGER**

- To reduce the risk of electrical shock

- 1** Always unplug the machine from the electrical outlet immediately after using, when cleaning, lubricating, making any user servicing adjustments mentioned in this manual, or if you are leaving the machine unattended.

### **⚠ WARNING**

- To reduce the risk of burns, fire, electrical shock, or injury to persons.

- 2** Always unplug the machine from the electrical outlet when making any adjustments mentioned in the instruction manual.

- To unplug the machine, switch the machine to the symbol "O" position to turn it off, then grasp the plug and pull it out of the electrical outlet. Do not pull on the cord.
- Plug the machine directly into the electrical outlet. Do not use an extension cord.
- Always unplug your machine if there is a power failure.

- 3** Electrical Hazards:

- This machine should be connected to an AC power source within the range indicated on the rating label. Do not connect it to a DC power source or converter. If you are not sure what kind of power source you have, contact a qualified electrician.
- This machine is approved for use in the country of purchase only.

- 4** Never operate this machine if it has a damaged cord or plug, if it is not working properly, has been dropped or damaged, or water is spilled on the unit. Return the machine to the nearest authorized Brother dealer for examination, repair, electrical or mechanical adjustment.

- While the machine is stored or in use if you notice anything unusual, such as an odor, heat, discoloration or deformation, stop using the machine immediately and unplug the power cord.
- When transporting the machine, be sure to carry it by its handle. Lifting the machine by any other part may damage the machine or result in the machine falling, which could cause injuries.
- When lifting the machine, be careful not to make any sudden or careless movements, which may cause a personal injury.

- 5** Always keep your work area clear:

- Never operate the machine with any air openings blocked. Keep ventilation openings of the machine and the foot controller free from the build up of lint, dust, and loose cloth.
- Do not store objects on the foot controller.
- Never drop or insert foreign objects in any opening.
- Do not operate where aerosol (spray) products are being used or where oxygen is being administered.
- Do not use the machine near a heat source, such as a stove or iron; otherwise, the machine, power cord or garment being sewn may ignite, resulting in fire or an electric shock.
- Do not place this machine on an unstable surface, such as an unsteady or slanted table, otherwise the machine may fall, resulting in injuries.

- 6** Special care is required when sewing:

- Always pay close attention to the needle. Do not use bent or damaged needles.
- Keep fingers away from all moving parts. Special care is required around the machine needle and the blades.
- Switch the machine to the symbol "O" position to turn it off when making any adjustments in the needle area.
- Do not use a damaged or incorrect needle plate, as it could cause the needle to break.
- Do not push or pull the fabric when sewing, and follow careful instruction so that you do not deflect the needle and cause it to break.

- 7** This machine is not a toy:

- Your close attention is necessary when the machine is used by or near children.
- This product contains small parts. Keep the product out of the reach of children to prevent accidental ingestion of small parts.
- The plastic bag that this machine was supplied in should be kept out of the reach of children or disposed of. Never allow children to play with the bag due to the danger of suffocation.
- Do not use the seam ripper in any other way than how it is intended.
- Do not use outdoors.

- 8** For a longer service life:

- When using and storing this machine, avoid direct sunlight and high humidity locations. Do not use or store the machine near a space heater, iron, halogen lamp, or other hot objects.
- Do not use cleansers or organic solvents, such as thinner, petroleum ether or alcohol, to clean the machine. Otherwise, the finish may peel off or become scratched.
- Always consult the Operation Manual when replacing or installing any assemblies, the presser feet, needle or other parts to assure correct installation.

- 9** For repair or adjustment:

- If the light unit is damaged, it must be replaced by an authorized Brother dealer.
- In the event a malfunction occurs or adjustment is required, first follow the troubleshooting table in the Operation Manual to inspect and adjust the machine yourself. If the problem persists, please consult your local authorized Brother dealer.

**Use this machine only for its intended use as described in the manual.**

**Use accessories recommended by the manufacturer as contained in this manual.**

**The contents of this manual and specifications of this product are subject to change without notice.**

**For additional product information and updates, visit our website at [www.brother.com](http://www.brother.com)**

# SAVE THESE INSTRUCTIONS

**This machine is intended for household use.**

## FOR USERS IN COUNTRIES EXCEPT EUROPEAN COUNTRIES

This appliance is not intended for use by persons (including children) with reduced physical, sensory or mental capabilities, or lack of experience and knowledge, unless they have been given supervision or instruction concerning use of the appliance by a person responsible for their safety. Children should be supervised to ensure that they do not play with the appliance.

## FOR USERS IN EUROPEAN COUNTRIES

This appliance can be used by children aged from 8 years and above and persons with reduced physical, sensory or mental capabilities or lack of experience and knowledge if they have been given supervision or instruction concerning use of the appliance in a safe way and understand the hazards involved. Children shall not play with the appliance. Cleaning and user maintenance shall not be made by children without supervision.

## **!** CAUTION

When leaving this sewing machine unattended, the main power and light switch of the machine must be switched off and then the plug must be removed from the socket-outlet.

When servicing the sewing machine, or when removing covers, the machine or the electrical set must be disconnected from the supply by removing the plug from the socket-outlet.

(For U.S.A. only)

This appliance has a polarized plug (one blade wider than the other). To reduce the risk of electric shock, this plug is intended to fit in a polarized outlet only one way. If the plug does not fit fully in the outlet, reverse the plug. If it still does not fit, contact a qualified electrician to install the proper outlet. Do not modify the plug in any way.

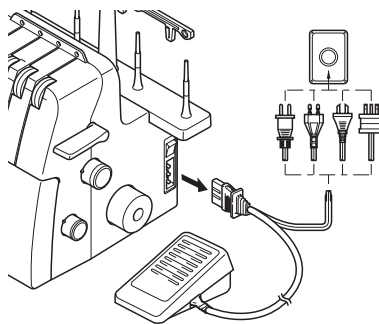

## FOR USERS IN THE UK, EIRE, MALTA AND CYPRUS ONLY

### IMPORTANT

- In the event of replacing the plug fuse, use a fuse approved by ASTA to BS 1362, i.e. carrying the  mark, rating as marked on plug.
- Always replace the fuse cover. Never use plugs with the fuse cover omitted.
- If the available electrical outlet is not suitable for the plug supplied with this equipment, you should contact your authorized Brother dealer to obtain the correct lead.

# CONGRATULATIONS ON CHOOSING THIS OVERLOCK MACHINE

Your machine is a high quality, easy-to-use product. To fully enjoy all the features, we suggest that you study this booklet.

If you need more information regarding the use of your machine, your nearest authorized dealer is always happy to be of service. Enjoy yourself!

## ⚠ CAUTION

When threading or replacing needle, the main power and light switch of the machine must be switched off and then the plug must be removed from the socket-outlet.

When the machine is not in use, it is recommended that the electric supply plug is disconnected from the wall socket to avoid any possible hazards.

## Notes on the motor

- The maximum operating speed of this sewing machine is 1,300 stitches per minute, which is quite fast compared to the normal operating speed of 300 to 800 stitches per minute for the ordinary sewing machine.
- The bearings in the main motor are made of a special material (oil-impregnated alloy mounted in felt heat-treated with oil) that enables them to withstand long hours of continuous operation.
- Continuous operation of the sewing machine can cause heat to build in the motor area, but not enough to adversely affect its performance. It is important to keep fabric and paper away from the air openings on the back, sides and bottom of the machine so air can get to these openings.
- When the main motor is running, sparks can be seen through the air openings in the cover on the same side as the handwheel. These sparks are produced by the carbon brushes and the commutator, and are part of the machine's normal operation.

## WARNING LABELS (for complying with UL and CSA requirements)

The following warning labels are on the machine.

Be sure to observe the precautions described in the labels.

Caution (U.S.A. and CANADA only)

① **CAUTION:**  
MOVING PARTS- TO AVOID INJURY:  
CLOSE COVER BEFORE SEWING.  
UNPLUG BEFORE SERVICING.

② **AVERTISSEMENT:**  
PARTIES EN MOUVEMENT. POUR  
ÉVITER TOUTE BLESSURE:  
FERMER LE CAPOT AVANT DE  
Coudre.  
DÉBRANCHER AVANT ENTRETIEN.

Label locations

(Inside the front cover)

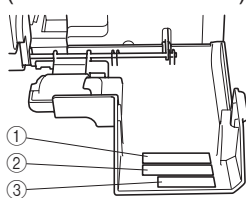

(Inside the material plate cover)

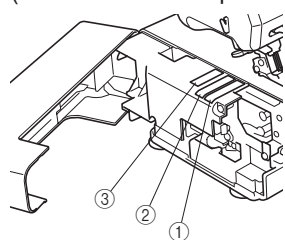

Face plate sticker (U.S.A. and CANADA only)

③ **CLOSE DOOR BEFORE  
OPERATING MACHINE**  
FERMER LE COUVERT AVANT  
D'OPÉRER LA MACHINE

# Contents

<b>CHAPTER 1: NAMES OF PARTS AND THEIR FUNCTIONS.....</b>	<b>4</b>
Accessories .....	5
Powering the machine .....	6
Turning direction of the handwheel.....	6
Opening/Closing the front cover and the knife cover .....	6
Using the presser foot lifting lever .....	7
Removing/Attaching the presser foot.....	7
Trim trap.....	8
Locking/Unlocking the upper knife .....	8
Stitch length .....	8
Stitch width .....	9
Differential feed.....	9
Adjusting the presser foot pressure .....	9
Thread tension dial .....	10
Examples of thread tension adjustment.....	10
Needle .....	12
Removing/Installing the needle.....	12
<b>CHAPTER 2: PREPARATION BEFORE THREADING .....</b>	<b>13</b>
Thread tree .....	13
How to use the thread spool cap .....	13
How to use the thread net.....	13
<b>CHAPTER 3: THREADING.....</b>	<b>14</b>
Before threading the loopers .....	14
Precautions for threading the loopers .....	14
Threading the lower looper .....	15
Threading the upper looper .....	15
After threading the loopers .....	16
When not to use air threading.....	16
Preparation before threading the needles .....	17
Threading the left needle .....	18
Threading the right needle.....	19
<b>CHAPTER 4: SEWING MATERIALS, THREADS AND NEEDLES COMPARISON CHART .....</b>	<b>20</b>
<b>CHAPTER 5: SEWING .....</b>	<b>21</b>
Safety mechanism .....	21
Test-sewing.....	21
Chaining-off.....	21
To start sewing.....	22
To remove work .....	22
To secure chains.....	22
If threads break during sewing.....	23
Stitch selection.....	23
Narrow overlock / Rolled hemming stitch .....	24
Two-thread sewing.....	25
<b>CHAPTER 6: TROUBLESHOOTING .....</b>	<b>27</b>
<b>CHAPTER 7: MAINTENANCE .....</b>	<b>29</b>
Cleaning.....	29
Opening the material plate cover .....	29
Cleaning the air threading pipes .....	29
Oiling.....	29
Replacing the knives.....	29
Transporting.....	29
<b>CHAPTER 8: INTRODUCTION OF OPTIONAL FEET.....</b>	<b>30</b>
Blind stitch foot .....	30
Taping (Elastic) foot .....	32
Pearl sequence foot.....	33
Piping foot.....	34
Gathering foot.....	35
<b>SPECIFICATIONS.....</b>	<b>36</b>
Specifications.....	36
<b>SETTING RECORD .....</b>	<b>37</b>

# CHAPTER 1

## NAMES OF PARTS AND THEIR FUNCTIONS

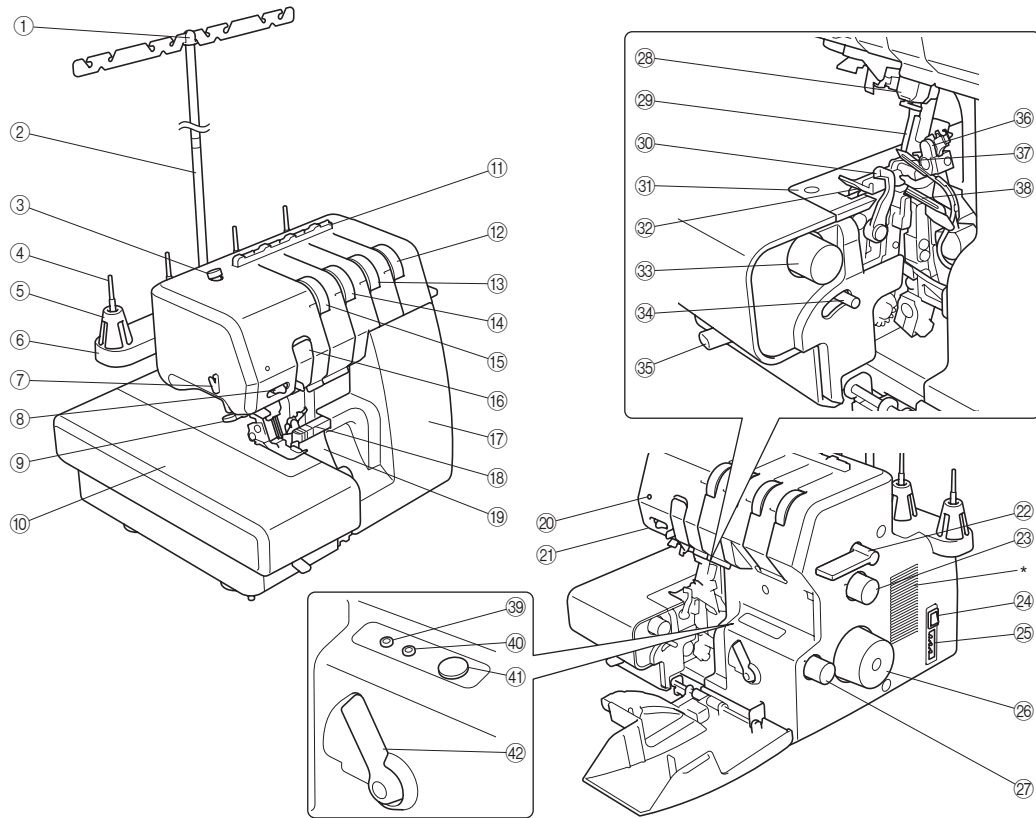

- ① Thread tree
- ② Telescoping thread
- ③ Presser foot pressure adjustment screw
- ④ Spool pin
- ⑤ Spool cushion
- ⑥ Spool support
- ⑦ Thread cutter
- ⑧ Needle threader change switch
- ⑨ Needle threader lever
- ⑩ Material plate cover
- ⑪ Thread guide
- ⑫ Lower looper thread tension dial
- ⑬ Upper looper thread tension dial
- ⑭ Right needle thread tension dial
- ⑮ Left needle thread tension dial
- ⑯ Thread take-up cover
- ⑰ Front cover
- ⑱ Seam allowance guide
- ⑲ Knife cover
- ⑳ Error indicator LED
- ㉑ LED lamp (inside the lamp cover)
- ㉒ Presser foot lifting lever
- ㉓ Stitch length adjustment dial
- ㉔ Main power and light switch
- ㉕ Foot controller inlet
- ㉖ Handwheel
- ㉗ Differential feed ratio adjustment dial
- ㉘ Needle clamp screw
- ㉙ Needles
- ㉚ Upper knife
- ㉛ Needle plate
- ㉜ Presser foot
- ㉝ Stitch width adjustment dial
- ㉞ Stitch switching lever
- ㉟ Knife lock lever
- ㊱ Two-thread-switching plate
- ㊲ Upper looper
- ㊳ Lower looper
- ㊴ Upper looper thread insertion hole
- ㊵ Lower looper thread insertion hole
- ㊶ Air threading pushbutton
- ㊷ Air threading switching lever

\* Air openings (6 places)

## Accessories

\* The included accessories vary depending on the machine model.

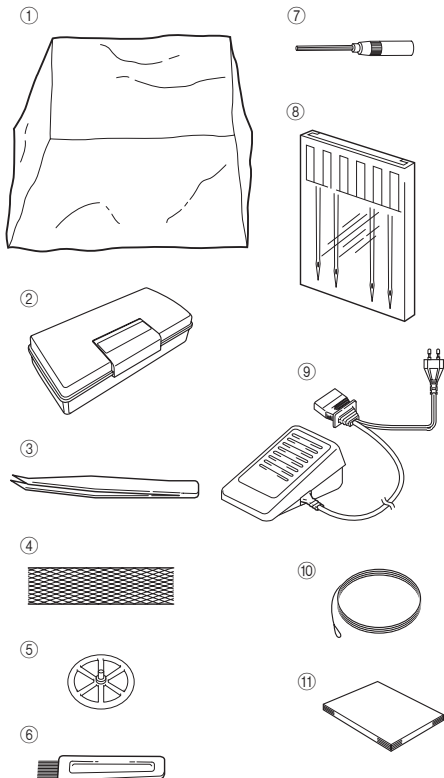

### Included accessories

- ① Soft cover: XB4350001
- ② Accessory box: XB3291001
- ③ Tweezers: XB1618001
- ④ Thread net (4): X75904000
- ⑤ Thread spool cap (4): X77260000
- ⑥ Cleaning brush: X75906001
- ⑦ Hexagonal driver: XB0393001
- ⑧ Needle set (130/705H): XB2772001  
#80: 2 pcs., #90: 2 pcs.
- ⑨ Foot controller:  
XB4341001 (120V Area)  
XB3112001 (220-230V Area)  
XB3134001 (U.K., Malaysia, United Arab  
Emirates, Saudi Arabia)  
XB3156001 (Korea)  
XB3190001 (Australia, New Zealand)
- ⑩ Threading wire: XB4370001
- ⑪ Operation manual

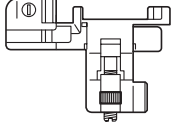

### Optional accessories

For further information about the following optional feet, see "CHAPTER 8 INTRODUCTION OF OPTIONAL FEET".

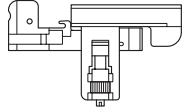
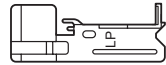
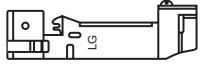
- ⑫ Blind stitch foot:  
SA214 (U.S.A., CANADA,  
EUROPE)  
SA214AP (OTHERS) 
- ⑬ Taping (Elastic) foot:  
SA212 (U.S.A., CANADA,  
EUROPE)  
SA212AP (OTHERS) 
- ⑭ Pearl sequence foot:  
SA217 (U.S.A., CANADA,  
EUROPE)  
SA217AP (OTHERS) 
- ⑮ Piping foot:  
SA210 (U.S.A., CANADA,  
EUROPE)  
SA210AP (OTHERS) 
- ⑯ Gathering foot:  
SA213 (U.S.A., CANADA,  
EUROPE)  
SA213AP (OTHERS) 
- ⑰ Trim trap: XB4329001

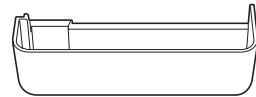

- ⑱ Wide table assembly:  
SAWT8 (U.S.A., CANADA)  
SERGERWT3 (EUROPE)  
WTL3 (OTHERS)

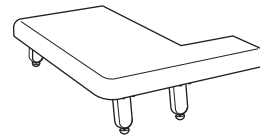

\* The part code differs depending on the product code or the color of the trim trap. Contact your authorized Brother dealer.

\* The product code is shown on the machine rating plate.

## Powering the machine

### Turning on the machine

1. Insert the three-pin plug into the foot controller inlet on the bottom right side of the machine. Insert the power supply plug into a power outlet.
2. Turn the main power and light switch <A> to "I" mark (to "O" mark to turn off).

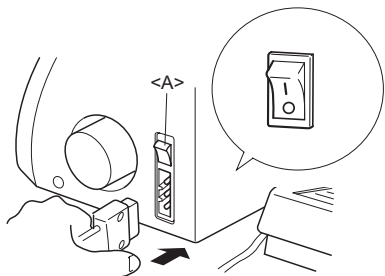

### Operation

When the foot controller is pressed lightly, the machine runs at a low speed. As the foot controller is pressed further, the machine increases speed. When the foot controller is released, the machine stops.

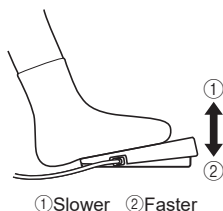

**NOTE (For U.S.A. only):**

Foot controller: Model KD-1902A

This foot controller can be used on the machine with product code 884-B20 and 884-B21

\* The product code is shown on the machine rating plate.

## Turning direction of the handwheel

The handwheel <A> turns in a counterclockwise direction (direction of arrow). This direction is the same as an ordinary home sewing machine.

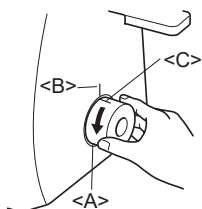

Before threading the machine, turn the handwheel so that mark <C> on the handwheel is aligned with line <B> on the machine.

## Opening/Closing the front cover and the knife cover

It is necessary to open the front cover and the knife cover when threading this machine. To open the front cover, grasp <A> with your finger and move the cover in the direction of the arrow.

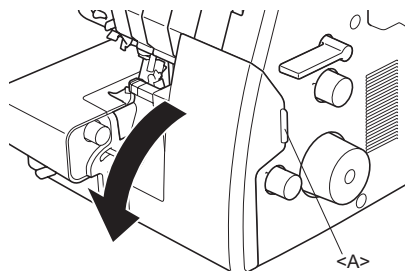

To open the knife cover, slide it to the right ①, and then move it in the direction of the arrow ②.

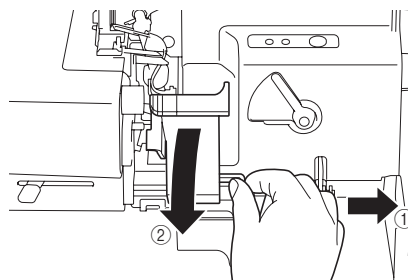

Closing the front cover also closes the knife cover.



## Using the presser foot lifting lever

For sewing (normal use), set the lever to the <A> position.

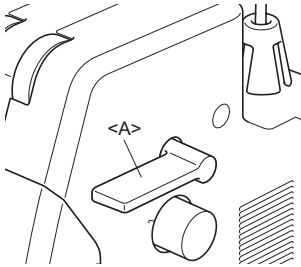

To raise the presser foot, raise the presser foot lifting lever to the <B> position.

Since raising the presser foot lifting lever opens the tension discs beside the thread tension dials, use this position for threading the machine.

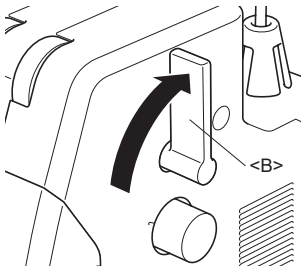

To increase the space between the presser foot and the needle plate, for example, when replacing the presser foot or sewing thick fabric, move the presser foot lifting lever further to the <C> position. When releasing the presser foot lifting lever from the <C> position, it returns to the <B> position.

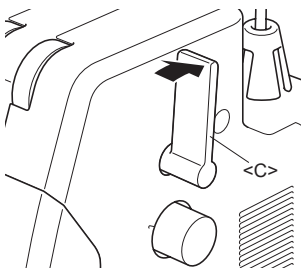

## Removing/Attaching the presser foot

1. Turn off the main power and light switch.
2. Raise the presser foot lifting lever ①.
3. Turn the handwheel ② so that the mark on the handwheel is aligned to the line on the machine. (See "CHAPTER 1 Turning direction of the handwheel".)

### Removing the presser foot

Push the button on the presser foot holder ③ and the presser foot will be released.

Raise the presser foot farther by pushing the presser foot lifting lever upward. Then remove the presser foot and store it in a safe location.

### Attaching the presser foot

Place the presser foot just under the presser foot holder <A> so that the groove in the bottom of the presser foot holder <B> is aligned and catches the bar on the top of the presser foot <C>. Then lower the presser foot lifting lever to attach the presser foot ④, pushing the button on the presser holder ⑤.

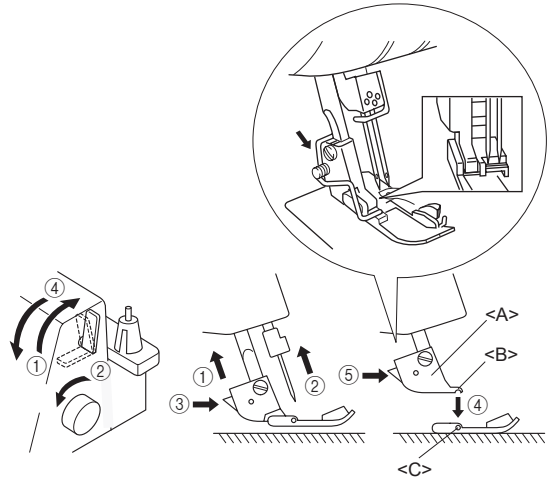

## Trim trap

### IMPORTANT

- Always remove the foot controller from the trim trap when carrying the machine.

The optional trim trap <A> holds the trimmed fabric and thread produced when sewing.

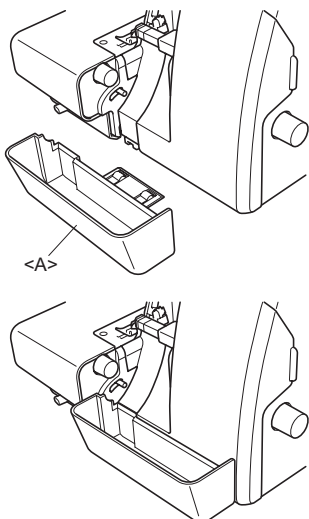

#### To install:

Insert the trim trap <A> until it contacts the front cover.

#### To remove:

Slowly pull out the trim trap.

#### NOTE:

The optional trim trap can also be used as the foot controller holder.

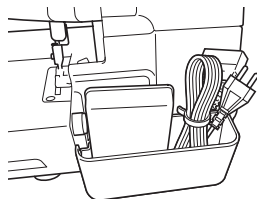

## Locking/Unlocking the upper knife

### CAUTION

- Do not touch the knives.
- Before switching between locking and unlocking the upper knife, make sure that the machine is completely stopped. If the knife lock lever is switched during sewing, fabric may become caught in the machine, causing the needle to become damaged, or the machine may be damaged or malfunction, causing injuries.

To use the upper knife, move the knife lock lever to the <A> position.

To sew without cutting the fabric, lock the upper knife by moving the knife lock lever to the right ①. The locked upper knife can be used as a guide.

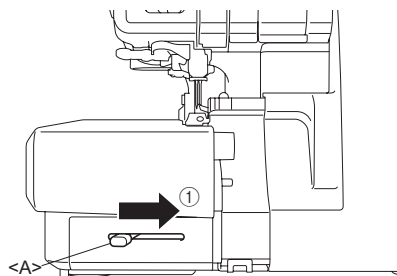

## Stitch length

The normal stitch length setting is 3 mm (1/8 inch). To change the stitch length, turn the stitch length adjustment dial on the right side of the machine.

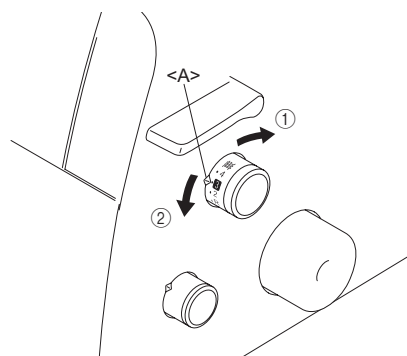

- ① Shorten the stitch length to a minimum of 2 mm (5/64 inch).
- ② Lengthen the stitch to a maximum of 4 mm (5/32 inch).

<A> Selection mark

## Stitch width

The normal stitch width setting for regular overlock stitch is 5 mm (13/64 inch). To change the stitch width, turn the stitch width adjustment dial.

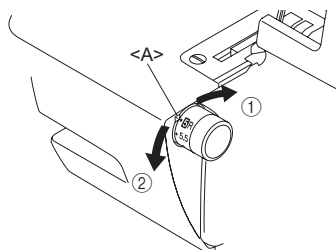

- ① Increase the width to a maximum of 7.5 mm (19/64 inch).
- ② Reduce the stitch width to a minimum of 5 mm (3/16 inch).

<A> Selection mark

## Differential feed

### IMPORTANT

- When sewing thick non-stretchable material such as denim, do not use the differential feed as it may damage the fabric.

This serger is equipped with two sets of feed dogs under the presser foot to move the fabric through the machine. The differential feed controls the movement of both the front and the rear feed dogs. When set at 1.0, the feed dogs are moving at the same speed (ratio of 1.0). When the differential feed ratio is set at less than 1.0, the front feed dogs move slower than the rear feed dogs, stretching the fabric as it is sewn. This is effective on lightweight fabric that may pucker. When the differential feed ratio is set at greater than 1.0, the front feed dogs move faster than the rear feed dogs, gathering the fabric as it is sewn. This function assists in removing the rippling when serging stretch fabrics.

### Differential feed adjustment

Differential feed ratio	Main feed (rear)	Differential feed (front)	Effect	Application
0.7 - 1.0			Material is pulled tight.	Prevents thin materials from puckering
1.0			Without differential feed.	Normal sewing

Differential feed ratio	Main feed (rear)	Differential feed (front)	Effect	Application
1.0 - 2.0			Material is gathered or pushed together.	Prevents stretch materials from stretching or puckering

The normal setting is 1.0 on the differential feed ratio adjustment dial.

To adjust the differential feed, turn the dial on the right bottom of the machine.

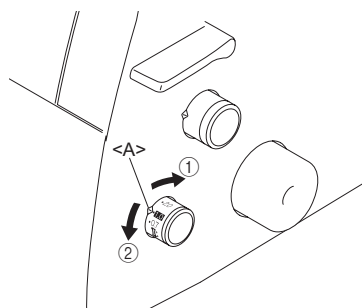

- ① Less than 1.0
  - ② Greater than 1.0
- <A> Selection mark

To get smooth finish, adjust the feed ratio from 1.0 toward 2.0.

(The feed ratio required depends on the elasticity of the material.)

The more elastic the material, the further toward 2.0 the differential feed ratio should be set. Test-sew with a scrap of the fabric to find the correct adjustment.

## Adjusting the presser foot pressure

Turn the presser foot pressure adjustment screw on the top left of the machine. You can adjust by referring the value on the screw.

The normal setting is "2".

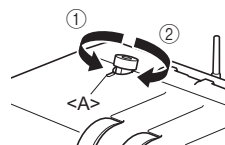

- ① Less pressure
  - ② More pressure
- <A> Selection mark

Adjust the presser foot pressure to prevent the material from puckering or to allow sewing of curves.

When sewing on very light materials, the presser foot pressure should be loosened. When sewing very heavy materials, the pressure foot pressure should be tightened.

## Thread tension dial

### IMPORTANT

- Make sure that the threads are properly seated in the tension dials.

There is a thread tension dial for each needle thread, the lower looper thread and the upper looper thread. The correct thread tension may vary according to the type and thickness of the fabric and the type of thread used. Thread tension adjustments may be necessary for any change in sewing materials.

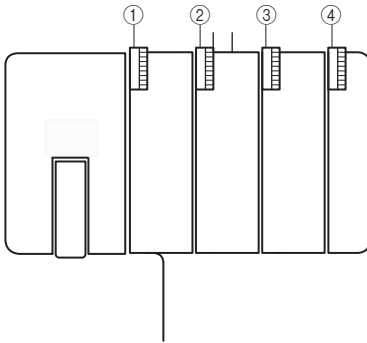

- ① Yellow marked tension dial is for left needle.
- ② Green marked tension dial is for right needle.
- ③ Pink marked tension dial is for upper looper.
- ④ Blue marked tension dial is for lower looper.

### Tension control

Sewing is possible at position "4" for most circumstances. (Standard: SPAN 60/2Z)

If the stitch quality is insufficient, select a different tension setting.

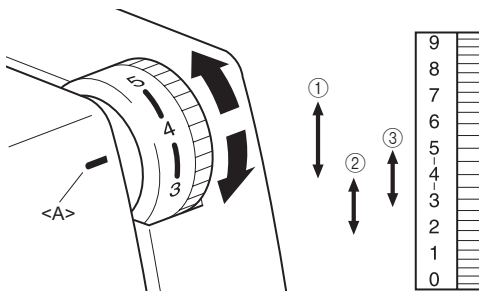

<A> Tension selection mark

- ① For heavy tension: 4 to 7
- ② For light tension: 4 to 2
- ③ For medium tension: 5 to 3

If you cannot find the correct tension, see "Examples of thread tension adjustment".

## Examples of thread tension adjustment

For correct overlock stitching, the looper threads and needle threads should be as described below.

- The upper looper thread and the lower looper thread are intertwined at the edge of the fabric.
- There is no looping in the needle threads on either the surface or the reverse of the fabric.

If the overlock stitching does not sew correctly, adjust the thread tension.

Move the thread tension dial by a half or quarter scale marking, and then continue sewing trial stitching and making adjustments.

### Left needle thread forms loops on reverse of fabric

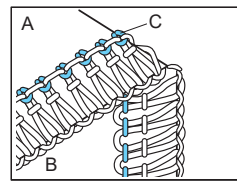

- A: Reverse
- B: Surface
- C: Left needle thread

Increase the tension of the left needle thread.

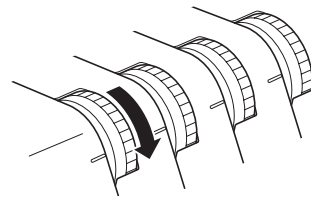

### Right needle thread forms loops on reverse of fabric

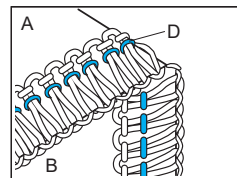

- A: Reverse
- B: Surface
- D: Right needle thread

Increase the tension of the right needle thread.

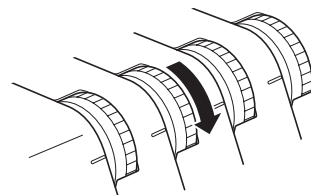

### Fabric puckers

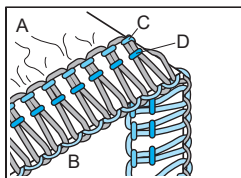

- A: Reverse
- B: Surface
- C: Left needle thread
- D: Right needle thread

Reduce the needle thread tension of the left needle thread first ①, then of the right needle thread ②.

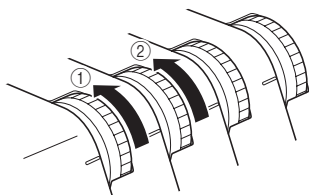

### Upper looper thread visible from reverse of fabric

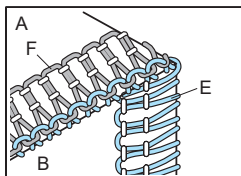

- A: Reverse
- B: Surface
- E: Upper looper thread
- F: Lower looper thread

Increase the tension of the upper looper thread, reduce the tension of the lower looper thread, or adjust both thread tensions.

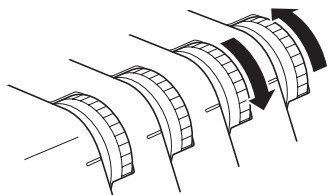

### Lower looper thread visible from surface of fabric

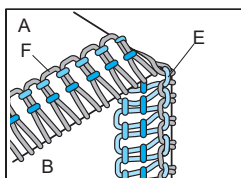

- A: Reverse
- B: Surface
- E: Upper looper thread
- F: Lower looper thread

Reduce the tension of the upper looper thread, increase the tension of the lower looper thread, or adjust both thread tensions.

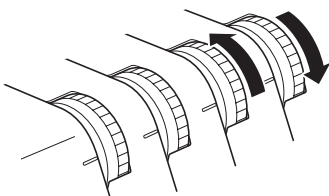

### Large loops because upper looper thread or lower looper thread extends past edge of the fabric

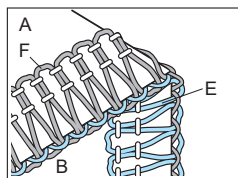

- A: Reverse
- B: Surface
- E: Upper looper thread
- F: Lower looper thread

Increase the tension of the upper looper thread and the lower looper thread.

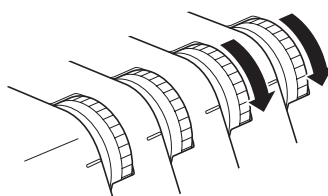

### Stitching puckers

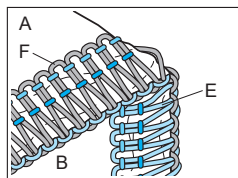

- A: Reverse
- B: Surface
- E: Upper looper thread
- F: Lower looper thread

Reduce the tension of the upper looper thread and the lower looper thread.

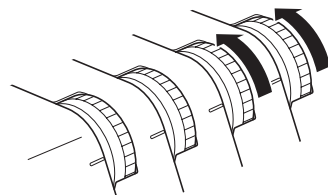

**NOTE:**

For details on these operations, watch the video.



<https://s.brother/cvtkb/>

## Needle

This machine uses a standard home sewing machine needle.

The recommended needle is 130/705H (#80 or #90).

### Needle description

- ① Back (flat side) ② Front ③ Groove

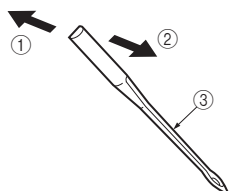

### How to check the needle

- ④ Flat surface  
⑤ Place the needle on its flat side and check to see if the space is parallel.

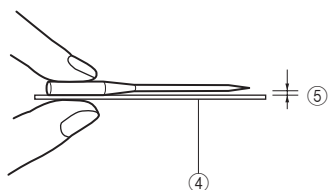

#### NOTE:

*It can reduce the occurrence of material breakage by using 130/705H SUK (#90) BALL POINT.*

## Removing/Installing the needle

### CAUTION

Always be sure to turn off the machine before removing/installing the needle.

### IMPORTANT

- Do not drop the needle or the needle set screw in the machine, otherwise it may be damaged.

<A> Removing/installing the left needle

<B> Removing/installing the right needle

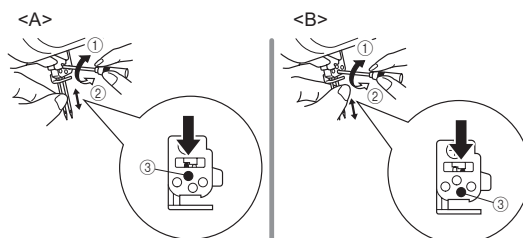

- ① Tighten ② Loosen ③ Needle set screw

#### To remove:

1. Turn the main power and light switch to the "O" position.
2. Turn the handwheel so that the mark on the handwheel is aligned to the line on the machine. (See "CHAPTER 1 Turning direction of the handwheel".)
3. Loosen the corresponding needle set screw ③ with turning the included hexagonal driver toward ② in the figure, and remove the needle.

#### To install:

1. Turn the main power and light switch to the "O" position.
2. Turn the handwheel so that the mark on the handwheel is aligned to the line on the machine.
3. Hold the needle with its flat side away from you and insert it up as far as it will go.
4. Tighten the corresponding needle set screw ③ securely with turning the included hexagonal driver toward ① in the figure.

#### NOTE:

*Make sure to insert the needles all the way. If the needles have been inserted correctly, the right needle should be set slightly lower than the left one.*

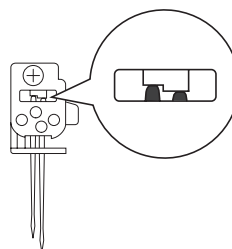

# CHAPTER 2

## PREPARATION BEFORE THREADING

### Thread tree

Fully insert the thread tree into the hole <A>.

After inserting the thread tree, fully extend it, and make sure that it is secured with the stopper. Make sure that the thread holders are directly above the spool pins as shown.

- ① Thread holder on thread tree
- ② Spool pin
- ③ Correct position

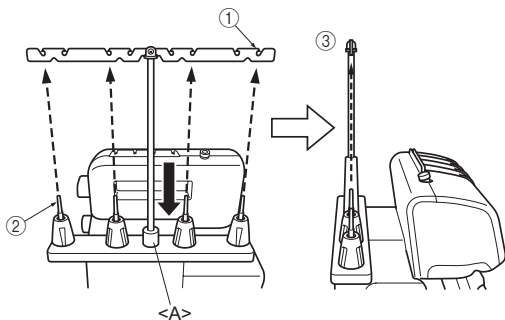

### How to use the thread spool cap

When using sewing thread spools, the thread spool cap should be used as illustrated below. Make sure that the spool notch is on the bottom.

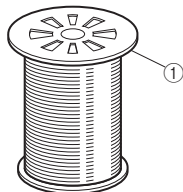

① Thread spool cap

### How to use the thread net

If you are sewing with loosely spun nylon thread, we recommend that you cover the spool with the thread net supplied to prevent the thread from slipping off the spool.

Adapt the net to the shape of the spool.

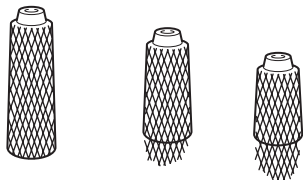

# CHAPTER 3 THREADING

## ⚠ CAUTION

Turn off the machine before threading for safety.

### Before threading the loopers

1. Raise the presser foot lifting lever to raise the presser foot.

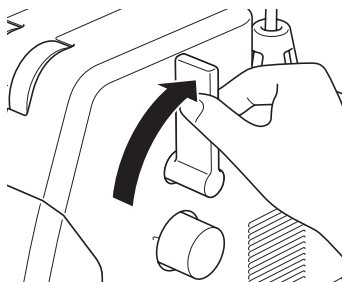

2. Open the front cover <A> and the knife cover <B>.

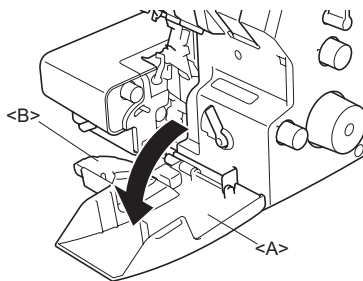

3. Move the air threading switching lever in the direction of the arrow.

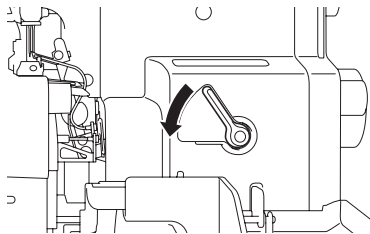

4. Turn the handwheel toward you until the pipes <C> snap into place to become joined.

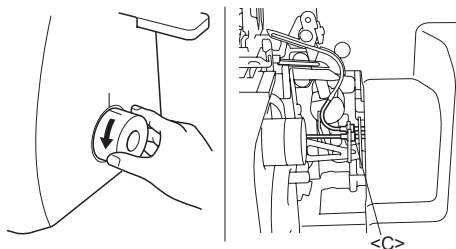

5. Turn the main power and light switch to the "I" position.

### Precautions for threading the loopers

#### IMPORTANT

- Use the air threading pushbutton only for threading. Do not use the air threading pushbutton for any purpose other than threading.
- Do not insert anything other than thread (or the threading wire) into the looper thread insertion hole. Otherwise, threading may no longer be possible, or damage may result.
- Do not allow liquids such as oil to adhere to the air threading pipes. Otherwise, threading may no longer be possible, or damage may result.
- When using the air threading pushbutton, do not look into or block (for example, with your finger) the hole at the end of the looper.
- Do not try to forcefully close the front cover without returning the air threading switching lever to the position where the pipes are separated. Otherwise, damage may result.

#### NOTE:

*Cutting the tip of the thread with scissors makes it easier to insert it into the looper thread insertion hole.*

*Any thread can be used for threading.*

*With air threading, it may not be possible to use woolly nylon threads or thick threads to thread the loopers. See "CHAPTER 3 When not to use air threading".*



## Threading the lower looper

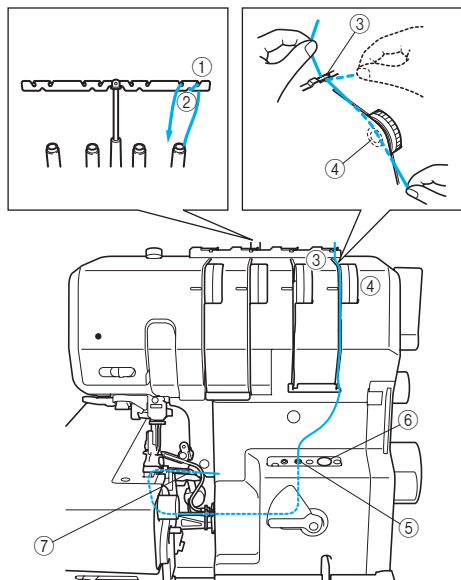

1. Pull the thread off the spool, and then thread ①, then ② of the thread tree from back to front.
2. Pass the thread through the thread guide ③ on the top of the machine.
3. Pass the thread through the tension disc ④ beside the lower looper thread tension dial.
4. Leaving 30 to 40 cm (12 to 16 inches) of excess thread, insert 1 to 2 cm (1/2 inch) of thread into the lower looper thread insertion hole ⑤, and then press the air threading pushbutton ⑥.

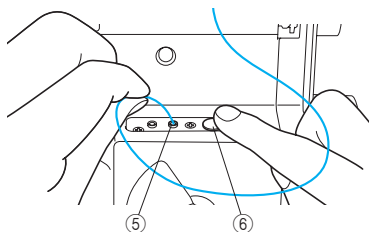

5. Make sure that the thread comes out of the hole ⑦ at the end of the lower looper.
6. Pull out the thread that came out of the hole at the end of the lower looper, pass it under the presser foot, and then pull it to the back of the machine ⑧.

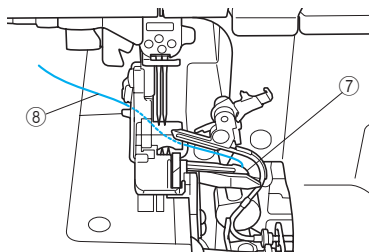

## Threading the upper looper

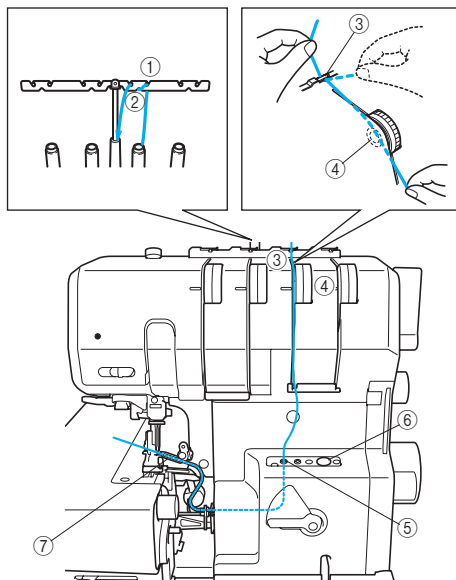

1. Pull the thread off the spool, and then thread ①, then ② of the thread tree from back to front.
2. Pass the thread through the thread guide ③ on the top of the machine.
3. Pass the thread through the tension disc ④ beside the upper looper thread tension dial.
4. Leaving 30 to 40 cm (12 to 16 inches) of excess thread, insert 1 to 2 cm (1/2 inch) of thread into the upper looper thread insertion hole ⑤, and then press the air threading pushbutton ⑥.

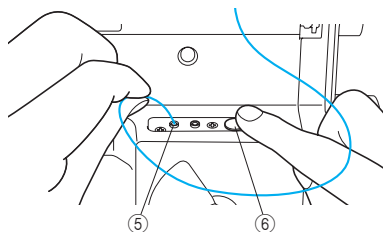

5. Make sure that the thread comes out of the hole ⑦ at the end of the upper looper.
6. Pull out the thread that came out of the hole at the end of the upper looper, pass it under the presser foot, and then pull it to the back of the machine ⑧.

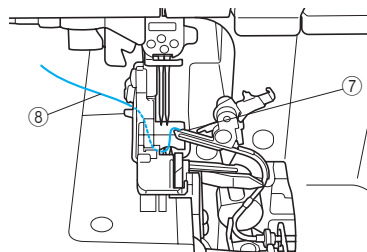

## After threading the loopers

1. To separate the pipes, move the air threading switching lever until locked.

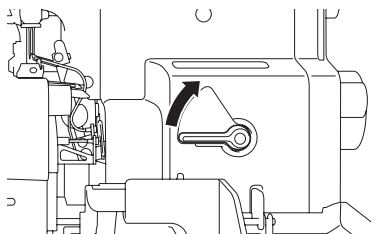

2. Close the front cover <A>. Closing the front cover also closes the knife cover <B>.

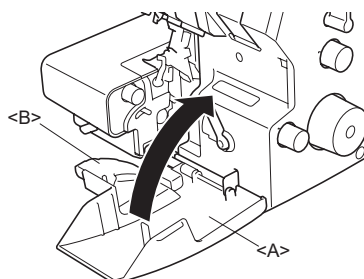

3. Lower the presser foot lifting lever.

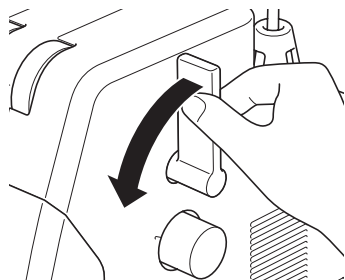

### NOTE:

The front cover will not close unless the pipes are separated.

## When not to use air threading

It may be difficult to insert woolly nylon thread or thick thread into the looper thread insertion hole, or threading with these types of thread may not be possible, even after pressing the air threading pushbutton.

In these cases, thread the loopers with either of the following methods.

- Using the included threading wire
- Using thread that can be used with air threading (spun thread)

## Using the threading wire

### CAUTION

Turn off the machine.

### IMPORTANT

- Do not press the air threading pushbutton while using the threading wire, otherwise the machine may be damaged.

1. Pass 2 to 3 cm (about 1 inch) of the sewing thread through the loop of the threading wire ①.

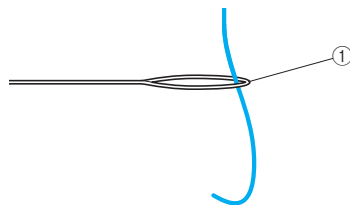

2. Insert the threading wire into the looper thread insertion hole ②.

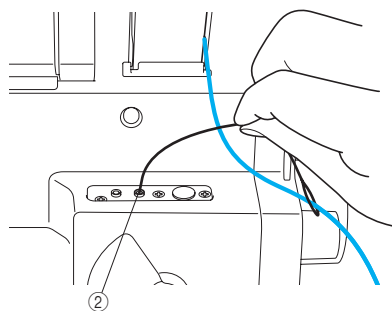

3. Feed in the threading wire by hand until it comes out of the hole ③ at the end of the looper.

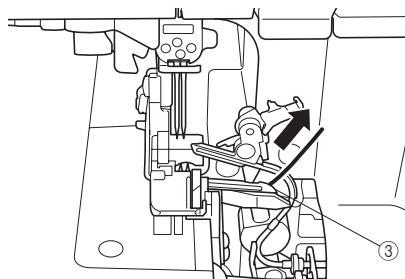

4. Pull out the threading wire until enough thread has come out ④.

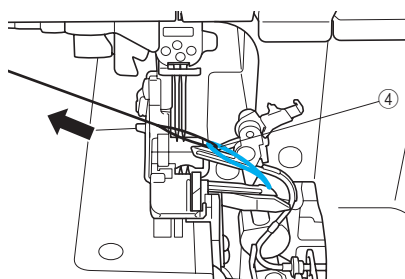

## Using spun thread

# ! CAUTION

Turn off the machine.

## IMPORTANT

- Do not press the air threading pushbutton while threading with the sewing thread, otherwise the machine may be damaged.
1. Use the air threading to thread the looper with spun thread.
  2. Cut the spun thread 20 to 30 cm (8 to 12 inches) from the looper thread insertion hole ①.

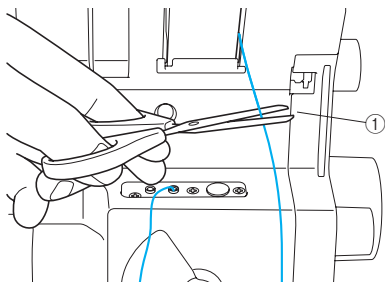

3. Thread the machine with the sewing thread up to the looper thread insertion hole.
4. Tie the sewing thread to the spun thread ②.

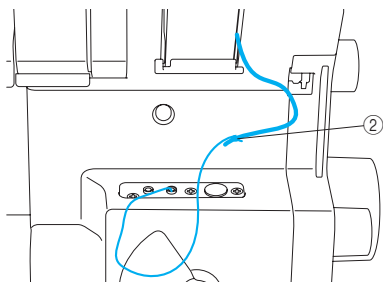

5. Pull the spun thread coming out of the hole at the end of the looper until enough sewing thread has come out ③.

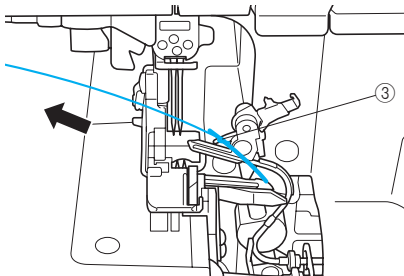

## Preparation before threading the needles

# ! CAUTION

For safety, turn off the machine before threading.

1. Raise the presser foot lifting lever to raise the presser foot.

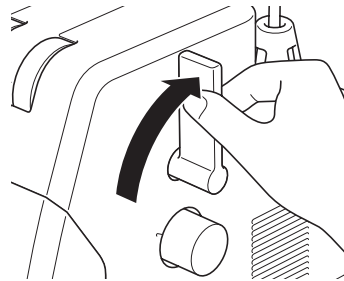

2. Turn the handwheel so that the mark on the handwheel <A> is aligned with the line on the machine <B>.

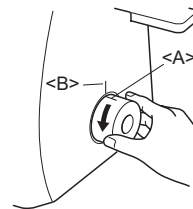

### NOTE:

When threading the needles after threading the loopers, the handwheel does not need to be turned since the mark on the handwheel and the line on the machine have already been aligned. If the machine has been turned on, turn it off.

## Threading the left needle

- Slide the needle threader change switch <A> to the "L" mark on the machine.

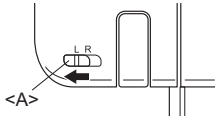

- Run the thread in the sequence illustrated, following the yellow color and the number next to each threading point.
  - Pull the thread off the spool and directly up through the thread holder ① and the thread holder ② on the thread tree from back to front.
  - Hold the thread with your left and right hands, then pass the thread through the thread guide ③, and then pass the thread through the tension disc ④ which is in the channel next to the yellow thread tension dial.
  - Guide the thread down the channel and across through the threading points ⑤ ⑥ ⑦ next to the yellow color marks following the numerical order in the accompanying illustration.

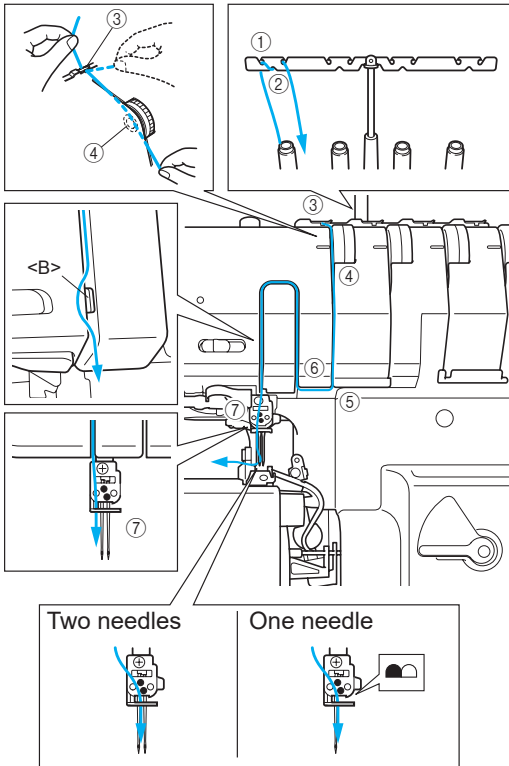

**NOTE:**

Make sure the thread is through the left of the separator <B>.

## Using the needle threader

The needle can be threaded by one-touch operation using the needle threader.

- Lower the presser foot lifting lever ① to lower the presser foot.

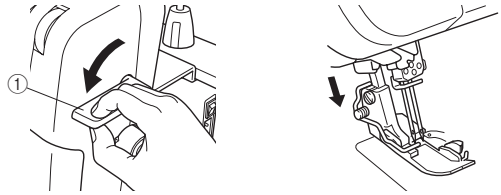

- Pull the end of the thread, which has been passed through the needle bar thread guide ②, to the left, then pass the thread through the notch of the thread guide ③, and then firmly pull the thread from the front and insert it into the slit of the thread guide disk ④ all the way.

**NOTE:**

Make sure that the thread passes the notch of the thread guide ③.

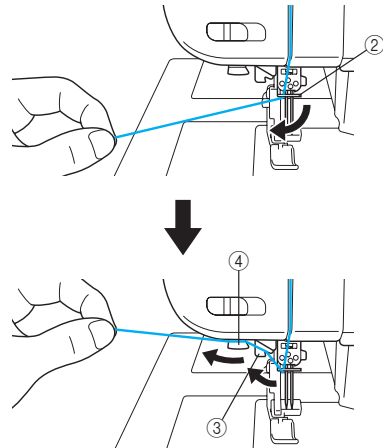

- Cut the thread with the thread cutter ⑤ on the left side of the machine.

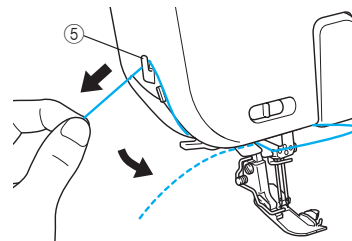

- Lower the needle threader lever ⑥ on the left side of the machine as much as possible.

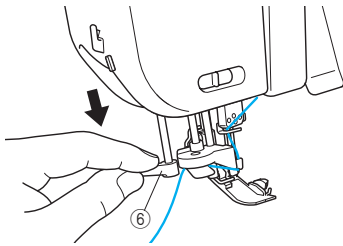

The thread passes through the eye of the needle.

- Release the needle threader lever ⑥.
- Carefully pull the loop of the thread through the eye of the needle to pull out the end of the thread.

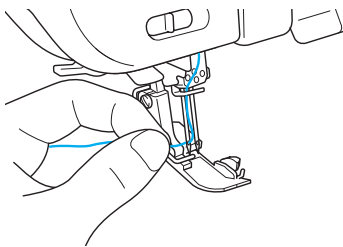

- Raise the presser foot lifting lever ①, then pass the end of the thread through the presser foot, and then pull out about 5 cm (2 inches) of thread toward the rear of the machine.

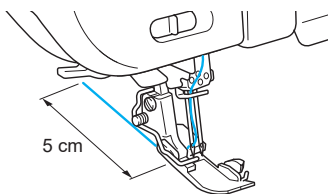

## Threading the right needle

- Slide the needle threader change switch <A> to the "R" mark on the machine.

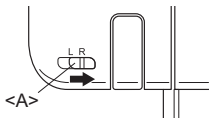

- Run the thread in the sequence illustrated, following the green color and the number next to each threading point.
  - Pull the thread off the spool and directly up through the thread holder ① and the thread holder ② on the thread tree from back to front.
  - Hold the thread with your left and right hands, then pass the thread through the thread guide ③, and then pass the thread through the tension disc ④ which is in the channel next to the green thread tension dial.

- Guide the thread down the channel and across through the threading points ⑤ ⑥ ⑦ next to the green color marks following the numerical order in the accompanying illustration.

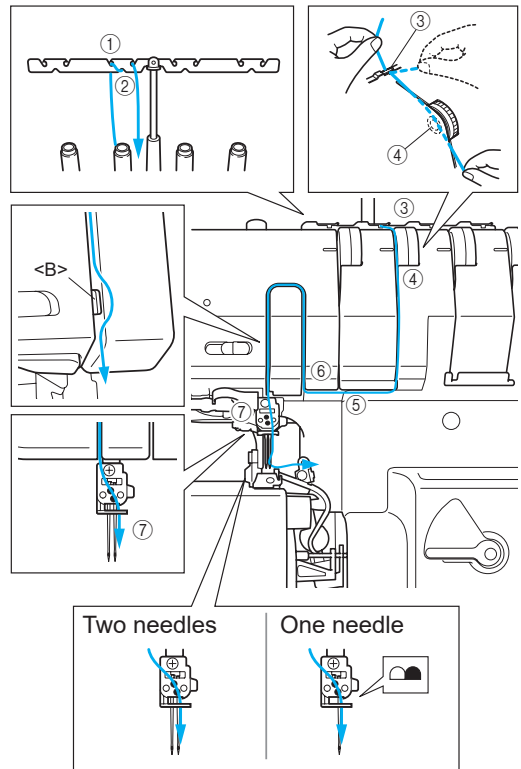

**NOTE:**

Make sure the thread is through the right of the separator <B>.

You can use the needle threader in the same way as for the left needle. (See "Using the needle threader")

**NOTE:**

For details on these operations, watch the video.



<https://s.brother/cvtkb/>

# CHAPTER 4

## SEWING MATERIALS, THREADS AND NEEDLES COMPARISON CHART

Material	Stitch	Stitch Length (mm)	Thread	Needle
Fine materials: Georgette Lawn Organdy Tricot	Overlock stitch	2.0-3.0	Spun #80-90 Cotton #100 Tetron #80-100	130/705H #80
Fine materials: Georgette Lawn Organdy Tricot	Narrow overlock / Rolled hemming stitch	R-2.0	Needle thread : Spun #80-90 Tetron #80-100  Looper thread : Woolly nylon thread Spun #80-90 Tetron #80-100	130/705H #80
Medium materials: Broad cloth Gabardine Serge	Overlock stitch	2.5-3.5	Spun #60-80 Cotton #60-80 Tetron #60-80	130/705H #80 #90
Medium materials: Broad cloth	Narrow overlock / Rolled hemming stitch	R-2.0	Needle thread : Spun #60-80 Tetron #60-80  Looper thread : Woolly nylon thread Spun #60-80 Tetron #60-80	130/705H #80 #90
Heavy materials: Tweed Denim Knits	Overlock stitch	3.0-4.0	Cotton #50-60 Spun #60 Tetron #50-60	130/705H #90

**NOTE:**

*Decorative thread will work best in the upper looper for fashion sewing.*

# CHAPTER 5 SEWING

## ⚠ CAUTION

- Do not touch moving parts (such as the knife, needles and loopers) and adjustment parts (such as dials and levers) during sewing.
- Do not open any cover during sewing.
- If any abnormality is noticed while using the machine, immediately stop it, and contact your authorized dealer.

### Safety mechanism

This machine is equipped with a safety mechanism in order to prevent misuse.

In the following cases, the red error indicator LED lights up, and the machine does not operate.

- The front cover is open.
- The material plate cover is open.
- The presser foot lifting lever is raised.

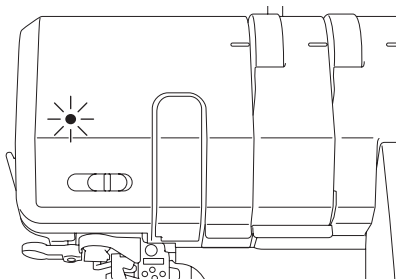

### Test-sewing

Turn on the machine and test-sew before you start sewing.

1. Set all the thread tension to "4".
2. Thread the machine and pull all threads out about 15 cm (6 inches) behind the presser foot.

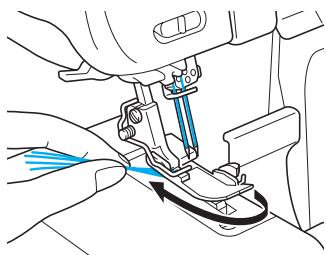

3. Place a piece of scrap material under the presser foot for test-sewing.

#### NOTE:

*Always lift the presser foot before placing the fabric under it. You cannot start sewing by just running the fabric under the presser foot without lifting it.*

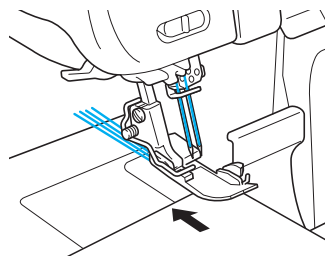

4. Holding all threads with your left hand, turn the handwheel slowly a few times toward you, and check to see that the threads entwine themselves before using the foot controller to sew.

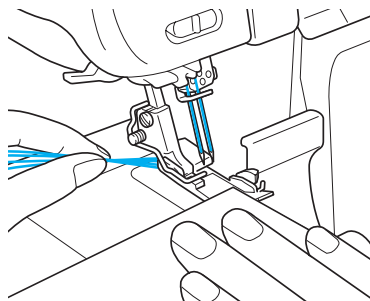

### Chaining-off

After test-sewing, continue to depress the foot controller slightly and chain off about 10 cm (4 inches). The threads will entwine themselves into a chain automatically.

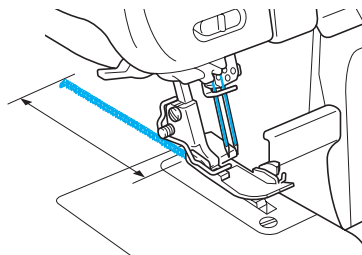

#### NOTE:

*If the thread tension is not correctly balanced, the chaining-off result will be uneven. If this happens, pull the threads slightly. Check the threading and adjust the thread tension to create an even chain. (See "CHAPTER 1 Thread tension dial".)*

## To start sewing

### ⚠ CAUTION

Do not leave straight pins in the fabric when sewing as they will damage the needles and the knives.

1. Thread the machine and pull all threads out about 15 cm (6 inches) behind the presser foot.

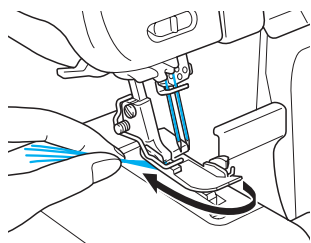

2. Lift the presser foot and place the material well underneath the presser foot before starting to sew. Lower the presser foot, and then turn the handwheel toward you to slowly sew a few stitches.
3. The fabric will be fed automatically. You need only guide it in the required direction.
4. Check the stitch formation (stitch chain) to see if it is uniform. If the stitch is not uniform, re-check that the threading has been done properly and in sequence.
5. Follow the seam allowance guide for consistent cutting of the fabric seams. The scale of seam allowance guide shows 9.5, 12.7, 15.9, and 25.4 mm (3/8, 1/2, 5/8, and 1 inch) when the stitch width adjustment dial is set to "5".

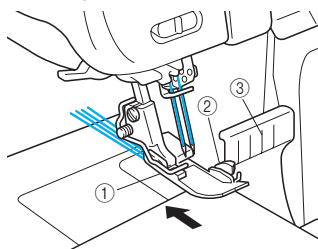

① Presser foot ② Upper knife ③ Seam allowance guide

## To remove work

When the seam is finished, keep the machine running at a low speed to obtain chaining-off. Then cut the stitches about 5 cm (2 inches) from the work. If feeding for chaining-off is not enough, pull the threads gently.

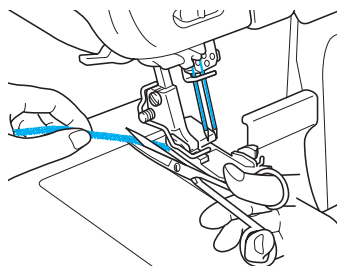

## To secure chains

There are two methods available to secure the chains.

### Method 1

Secure the chains of the beginning and the end of a stitch with your machine.

#### At the beginning of a stitch

1. Sew a few stitches, after chaining-off for about 5 cm (2 inches).
2. Stop the machine and raise the presser foot.
3. Put the chains under the presser foot, and serge over it pulling toward you.
4. After sewing a few stitches, cut off the extra chain with the upper knife as illustrated.

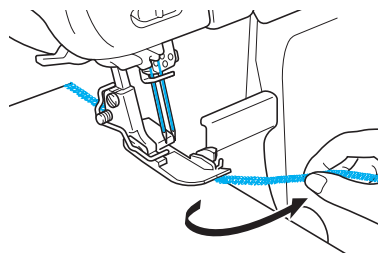

#### At the end of a stitch

1. At the end of the seam, sew one stitch out of the fabric before stopping the machine.

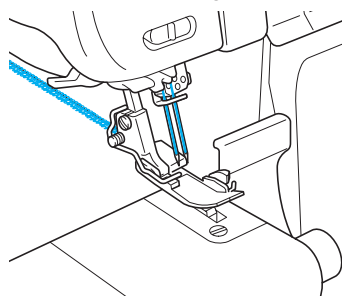



2. Raise the presser foot and the needles, then reverse the fabric.

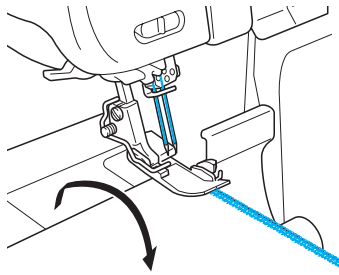

3. Lower the needles and the presser foot at the same position.
4. Serge over the seam, taking care not to cut the serged seam with the upper knife.
5. After sewing a few stitches, serge off the fabric as illustrated.

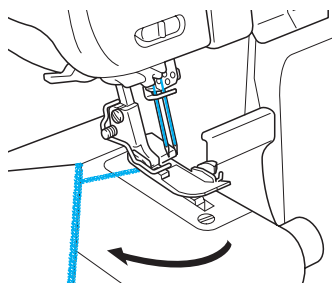

6. Cut the chain with scissors.

### Method 2

With this method, the chains of the beginning and the end of a stitch can be secured in the same manner.

1. Tie the thread unpicked from chains.

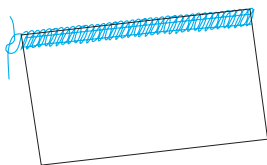

2. Insert the chains into the end of the seam, using a hand sewing needle with large eye.

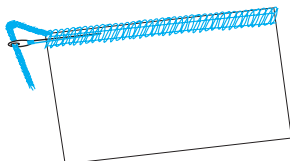

3. Fix the chains with a drop of fabric glue, and cut the extra stitches after drying.

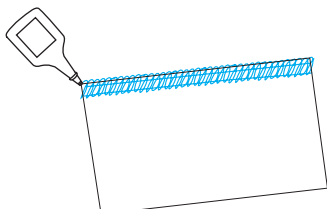

## If threads break during sewing

Remove the material and re-thread (to re-thread, see "CHAPTER 3 THREADING"). Replace the material under the presser foot and sew 3-5 cm (1 to 2 inches) over the previous stitches.

If either of the looper threads breaks during sewing, also remove the unbroken looper thread, and then thread both loopers again.

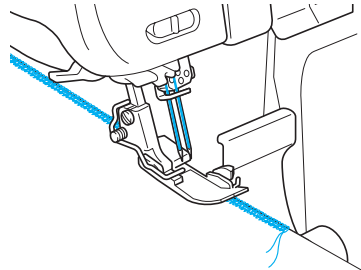

## Stitch selection

Select the stitch pattern before you start sewing.

### Four-thread overlock stitch

Use all four threads and two needles for producing four-thread overlock stitches.

Use: Produces strong seam. Ideal for sewing knits and wovens.

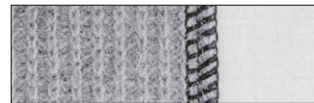

### Three-thread overlock stitch 5 mm (3/16 inch)

Use three threads and the left needle, producing 5 mm (3/16 inch) seams.

Use: For overlock stitching on suits, blouses, slacks, etc. Ideal for medium to heavy materials.

#### NOTE:

Remove the right needle when sewing this overlock stitch.



### Three-thread overlock stitch 2.8 mm (7/64 inch)

Use three threads and the right needle, producing 2.8 mm (7/64 inch) seams.

Use: For overlock stitching on suits, blouses, slacks, etc. Ideal for fine to medium materials.

**NOTE:**

Remove the left needle when sewing this overlock stitch.

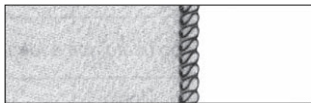

### Narrow overlock / Rolled hemming stitch

The Narrow overlock / Rolled hemming stitch is a decorative finish for lightweight to midweight fabrics. It is often used to complete the edge of a fabric. This stitch is sewn by removing the left needle and using the 3-thread overlock stitch.

Use as decorative or finishing stitch.

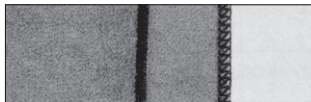

### Two-thread overlock stitch 5 mm (3/16 inch)

Use two threads and the left needle, producing 5 mm (3/16 inch) seams.

Use: For overlock stitching on suits, blouses, slacks, etc. Ideal for fine to medium materials.

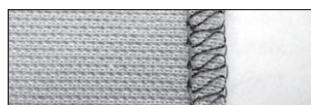

### Two-thread overlock stitch 2.8 mm (7/64 inch)

Use two threads and the right needle, producing 2.8 mm (7/64 inch) seams.

Use: For overlock stitching on suits, blouses, slacks, etc. Ideal for fine to medium materials.

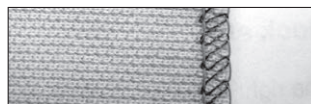

## Narrow overlock / Rolled hemming stitch

### Instructions for Narrow overlock / Rolled hemming stitch

# CAUTION

Turn off the machine before removing/installing the needle.

**NOTE:**

For the recommended thread and needle, see "CHAPTER 4 SEWING MATERIALS, THREADS AND NEEDLES COMPARISON CHART".

1. Remove the left needle.

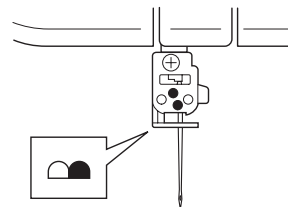

2. Thread the machine for the three-thread overlock, using the right needle.
3. Pull lever <A> toward you to lower the stitch finger.

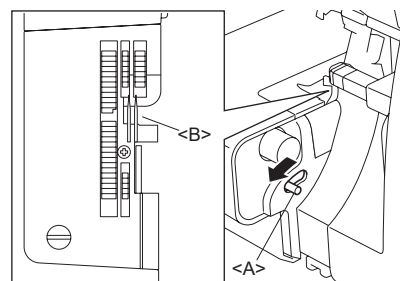

<B>: Stitch finger lowered

**NOTE:**

For normal overlock stitching, the stitch finger is used. In that case, return the stitch switching lever <A> to its original position.

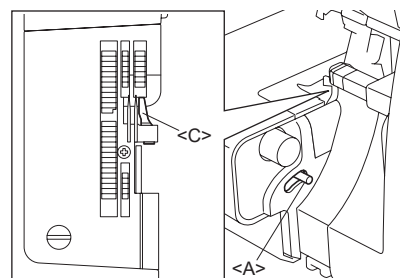

<C>: Stitch finger raised

4. Adjust the stitch width adjustment dial up to the "R" position.

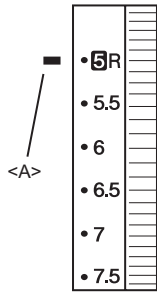

<A> Selection mark

5. Adjust the stitch length.  
Set the stitch length adjustment dial to "R" to "2" position (for narrow overlock stitch: "R" to "2", for rolled hemming stitch: "R").

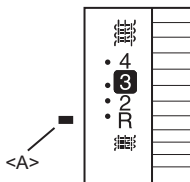

<A> Selection mark

### Chart of Narrow overlock / Rolled hemming stitch

For details on recommended materials and threads for the needles, the upper looper and the lower looper, see "CHAPTER 4 SEWING MATERIALS, THREADS AND NEEDLES COMPARISON CHART".

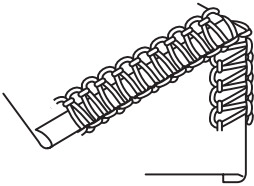
Narrow overlock stitch	
Stitch style	Reverse  Surface
Stitch length	R (R-2.0)
Stitch width	R (R-6)
Stitch finger	Lowered
Thread tension	For fine materials      For medium materials
Needle thread	4 (3 - 5)                  4 (3 - 5)
Upper looper thread	4 (3 - 5)                  4 (3 - 5)
Lower looper thread	4 (3 - 5)                  4 (3 - 5)

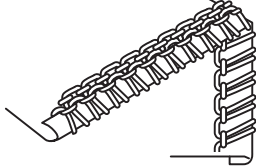
Rolled hemming stitch	
Stitch style	Reverse  Surface
Stitch length	R (R-2.0)
Stitch width	R (R-6)
Stitch finger	Lowered
Thread tension	For fine materials      For medium materials
Needle thread	5 (4 - 6)                  5 (4 - 6)
Upper looper thread	5 (4 - 6)                  5 (4 - 6)
Lower looper thread	6 (5 - 7)                  6 (5 - 7)

## Two-thread sewing

### Setting the two-thread-switching plate

## CAUTION

Turn off the machine before setting the two-thread-switching plate.

1. Open the front cover <A> and the knife cover <B>.

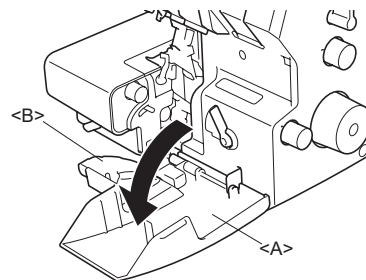

2. Turn the handwheel so that the mark on the handwheel <C> is aligned with the line on the machine <D>.

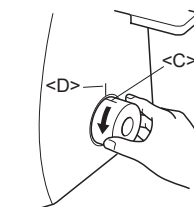

- Set the two-thread-switching plate.  
Move part <E> of the two-thread-switching plate in the direction of the arrow to insert its tip into the eye at the end of the upper looper from behind.

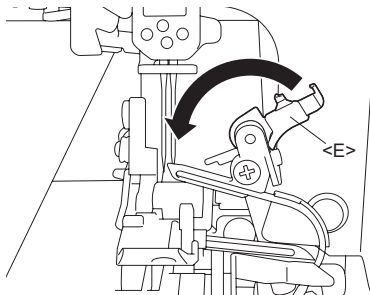

**NOTE:**  
Make sure that the tip is in the eye of the upper looper ①.

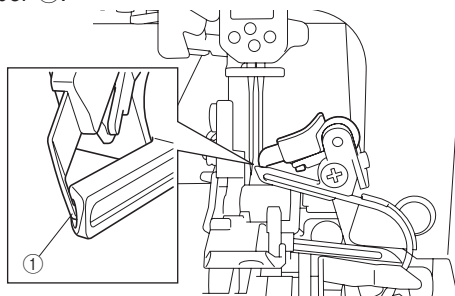

### Releasing the two-thread-switching plate

- Push area <A> of the two-thread-switching plate to the back to remove the tip from the eye at the end of the upper looper, and then move it in the direction of the arrow.

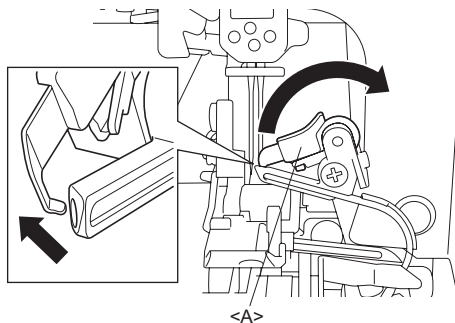

- Close the front cover <B>.  
Closing the front cover also closes the knife cover <C>.

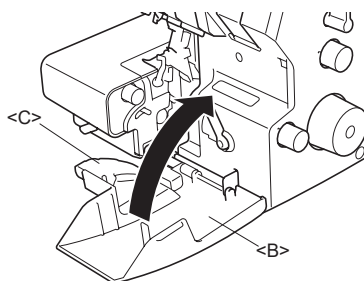

### Chart of two-thread overlock stitch

Stitch style	Reverse	
Stitch length	3	
Stitch width	5 - 7.5	
Stitch finger	Raised	
Thread tension	For fine materials	For medium materials
Left needle thread	2 (1 - 3)	2 (1 - 3)
Lower looper thread	6 (5 - 7)	6 (5 - 7)
Right needle thread	2 (1 - 3)	2 (1 - 3)
Lower looper thread	6 (5 - 7)	6 (5 - 7)

**NOTE:**  
For details on these operations, watch the video.



<https://s.brother/cvtkb/>

# CHAPTER 6

## TROUBLESHOOTING

This sewing machine is designed for trouble-free operation. However, the following chart indicates trouble which may occur if basic adjustments are not made properly.

Trouble	Cause	Remedy
1. Does not feed	1. Thread tangled	Thread correctly. (See pages 14 - 19.)
	2. Presser foot pressure too loose	Turn the presser foot pressure adjustment screw clockwise to increase the presser foot pressure. (See page 9.)
2. Needles break	1. Needles bent, or needle tip blunt	Replace with new needles. (See page 12.)
	2. Needles incorrectly installed	Install needles correctly. (See page 12.)
	3. Material pulled forcibly	Do not press or pull material too hard when sewing.
3. Threads break	1. Improper threading	Thread correctly. (See pages 14 - 19.)
	2. Thread tangled	Check spool pin, thread holders, etc. and remove tangled thread.
	3. Thread tension too tight	Adjust the thread tension. (See pages 10 - 11.)
	4. Needles incorrectly installed	Install needles correctly. (See page 12.)
	5. Wrong needles used	Use correct needles. 130/705H - suggested (See page 12.)
4. Skipped stitches	1. Needles bent, or needle tip blunt	Replace with new needles. (See page 12.)
	2. Needles incorrectly installed	Install needles correctly. (See page 12.)
	3. Wrong needles used	Use correct needles. 130/705H - suggested (See page 12.)
	4. Improper threading	Thread correctly. (See pages 14 - 19.)
	5. Presser foot pressure too loose	Turn the presser foot pressure adjustment screw clockwise to increase the presser foot pressure. (See page 9.)
	6. Tip of two-thread-switching plate not in eye of upper looper	Insert the tip of the two-thread-switching plate into the eye of the upper looper. (See pages 25 - 26.)
5. Stitches are not uniform	1. Thread tensions are not adjusted properly	Adjust the thread tension. (See pages 10 - 11.)
	2. Improper threading	Thread correctly. (See page 14 - 19.)
6. Fabric is puckered	1. Thread tension too tight	Decrease thread tension when sewing lightweight or fine material. (See pages 10 - 11.)
	2. Improper threading or thread tangled	Thread correctly. (See pages 14 - 19.)
	3. Differential feed ratio adjustment dial not set to appropriate scale marking	Set the dial to an appropriate scale marking. (See page 9.)

<b>Trouble</b>	<b>Cause</b>	<b>Remedy</b>
7. Knife does not cut fabric	1. Blade worn	Replace the knife with a new one. Contact your authorized Brother dealer.
	2. Knife lock lever set to lock knife	Move the knife lock lever to unlock the knife. (See page 8.)
8. Thread not passing through eye of needle	1. Incorrect threading position	Correctly position the mark on the handwheel. (See page 6.)
	2. Improper threading	Thread correctly. (See pages 14 - 19.)
	3. Needle threader change switch incorrectly set	Set the needle threader change switch correctly. (See pages 18 - 19.)
	4. Needles incorrectly installed	Install needles correctly. (See page 12.)
9. Looper not threaded	1. Pipes not joined	Move the air threading switching lever, and then turn the handwheel toward you until the pipes become joined. (See page 14.)
	2. Not enough thread inserted into looper thread insertion hole	Insert 1 to 2cm (1/2 inch) of thread into the looper thread insertion hole. (See page 15.)
	3. No excess thread before inserting into looper thread insertion hole	Leave 30 to 40 cm (12 to 16 inches) of excess thread before inserting it into the looper thread insertion hole. (See page 15.)
	4. Thread caught somewhere	Release the thread from where it is caught.
	5. Lint accumulated in pipe	Using the included threading wire, thread the looper to remove the lint from the pipe. (See page 29.)
	6. Thread (such as woolly nylon thread and thick thread) used is difficult to insert into looper thread insertion hole	Thread using the threading wire or the spun thread. (See pages 16 - 17.)
10. Machine not operating	1. Machine not turned on	Turn on the machine. (See page 6.)
	2. Power supply plug not inserted into power outlet	Insert the power supply plug into a power outlet. (See page 6.)
	3. Presser foot lifting lever raised	Lower the presser foot lifting lever. (See page 7.)
	4. Material plate cover, front cover, or both open	Check for open covers, and then close them. (See pages 6 and 29.)

# CHAPTER 7 MAINTENANCE

## Cleaning

### ⚠ CAUTION

Turn off the machine before cleaning.

Lint accumulates when the machine is used. After using the machine, periodically remove dust and trimmed fabric and thread with the included cleaning brush.

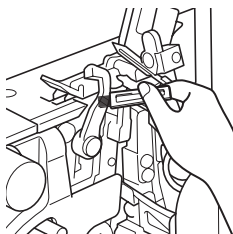

## Opening the material plate cover

### IMPORTANT

- Before opening the material plate cover, make sure that there is enough space on the left of the machine and that no people or objects obstruct the area.
- Do not apply excessive force to the material plate cover or try raising it. Otherwise, it may be damaged. When closing the material plate cover, be careful that your fingers or clothing do not become caught.
- Make sure that the material plate cover is firmly closed.

Slide the material plate cover in the direction of the arrow to open it.

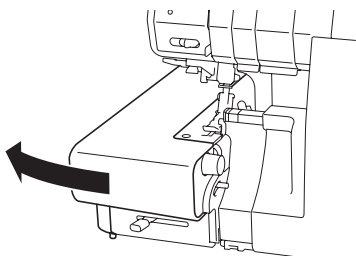

## Cleaning the air threading pipes

Use the included threading wire to clean the looper pipes.

1. Join the pipes. (See "CHAPTER 3 Before threading the loopers".)
2. Insert the threading wire into the thread insertion hole, and then pull out the wire coming out of the end of the looper. (See "CHAPTER 3 When not to use air threading".)
3. Repeat this operation several times.

## Oiling

### ⚠ CAUTION

Turn off the machine before opening the front cover and oiling.

For smooth and silent operation, the moving parts (indicated with the arrows) of the machine should be oiled periodically.

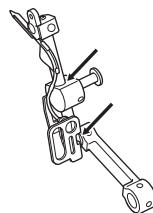

### NOTE:

*Always clean the lint off your machine before you apply oil.*

*Oil the machine once or twice a month for normal use. If the machine is used more often, oil it once a week.*

*Use only good quality sewing machine oil.*

## Replacing the knives

When the knives no longer cut fabric, they must be replaced.

Contact your authorized dealer.

## Transporting

### ⚠ CAUTION

When transporting the machine, be sure to carry it by its handle.

If the machine is carried by any part other than the handle, the machine may fall or be damaged.

### IMPORTANT

- Always remove the foot controller from the trim trap when carrying the machine.

Grasp the handle to transport the machine.

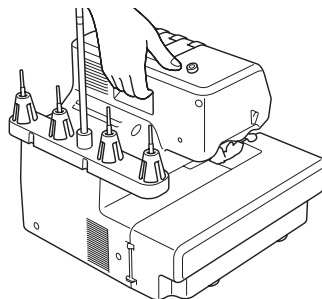

# CHAPTER 8 INTRODUCTION OF OPTIONAL FEET

## ! CAUTION

Turn off the machine while replacing the presser foot.

### Blind stitch foot

#### Features

When using the blind stitch presser foot (multi-purpose foot), you can sew blind stitches and overlock at the same time. This is ideal when sewing cuffs, trouser bottoms, pockets, and hemming skirts etc.

The stitch guide on this foot is also useful when sewing special stitches like flatlock, pin tuck and other decorative stitches.

#### Blind stitching

The blind hem stitch is used for putting a near invisible hem in garments or home decoration projects. Use it to hem pants, skirts, or draperies.

#### Recommended settings

- Stitch Width: 5 mm
- Stitch Length: 3 - 4 mm
- Left Needle Thread Tension: Slackened (0-2)
- Upper Loper Thread Tension: Tightened (5-7)
- Lower Loper Thread Tension: Slackened (2-4)

#### Procedure

1. Attach the blind stitch foot (see "CHAPTER 1 Removing/Attaching the presser foot").
2. Set up the machine for 3-thread overlock stitch with one needle in the left position. The right needle should be removed.
3. Turn the wrong side of the fabric out, fold the fabric once and then back to the required width, as illustrated.

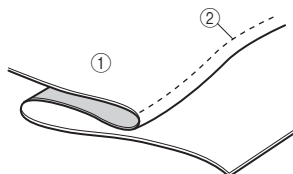

- ① Reverse
- ② Needle path

Sewing will be easier if a crease is ironed into the folded fabric before sewing.

4. Turn the handwheel so that the mark on the handwheel is aligned to the line on the machine (see "CHAPTER 1 Turning direction of the handwheel").

5. Lift the presser foot lifting lever and insert the fabric with the folded edge on the left in such a way that the needle pierces just the folded edge as it sews.
6. Lower the presser foot lifting lever, adjust the fabric guide toward the folded edge.
7. Adjust the fabric guide position of the presser foot with the adjusting screw so that the needle is lightly touching the crease in the fabric. In this case, the thickness of the fabric is the criterion. By turning the screw forward (toward you), the fabric guide will go to the right. By turning the screw backward (away from you), the fabric guide will go to the left.

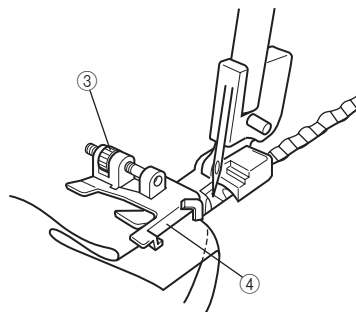

- ③ Adjusting screw
- ④ Fabric guide

To adjust the position of the fabric guide, a piece of the same fabric should be used to do a sewing test.

8. While folding the fabric by hand, sew so that the needle just catches the edge of the crease.
9. Open the fabric as shown in the illustration.

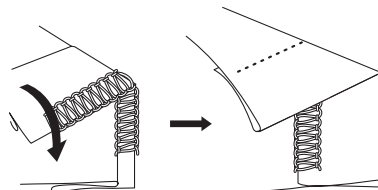

For best results, use a fine thread in a color that matches the fabric.

When done correctly, this stitch will be very hard to see on the right side of the fabric.

#### Flatlock stitching

The Flatlock stitch is primarily used as a decorative finish on a project. The finished stitch can look like a ladder or small parallel lines when the fabric is pulled flat.

#### Recommended settings

- Stitch Width: 5 mm
- Stitch Length: 2 - 4 mm
- Left Needle Thread Tension: 0-3
- Upper Loper Thread Tension: 2-5
- Lower Loper Thread Tension: 6-9



## Procedure

1. Attach the blind stitch foot (see "CHAPTER 1 Removing/Attaching the presser foot").
2. Set up the machine for 3-thread overlock stitch with one needle in the left position. The right needle should be removed.
3. Fold the fabric as shown in the illustration.

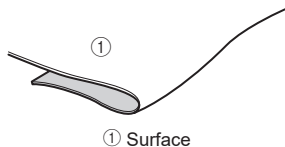

4. Turn the handwheel so that the mark on the handwheel is aligned to the line on the machine (see "CHAPTER 1 Turning direction of the handwheel").
5. Lift the presser foot lifting lever and insert the fabric with the folded edge in such a way that the needle pierces just on the fold.
6. Lower the presser foot lifting lever, adjust the fabric guide toward the folded edge.
7. Adjust the fabric guide position of the presser foot with the adjusting screw so that the needle moves down to a position 1/8 inch (2.5 to 3.0 mm) inside the folded edge of the fabric, so that some of the stitching loops over the edge.

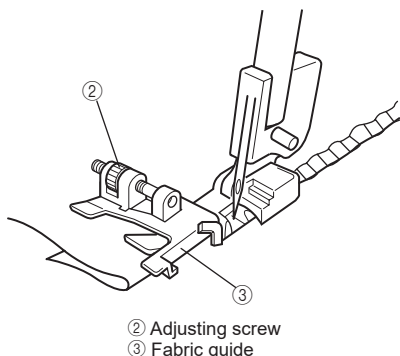

By turning the screw forward (toward you), the fabric guide will go to the right. By turning the screw backward (away from you), the fabric guide will go to the left.

To adjust the position of the fabric guide, a piece of the same fabric can be used to do a sewing test.

8. While holding the fabric pieces together, sew at a constant speed down the fold.
9. When stitching is finished, pull the fabric open (flat).

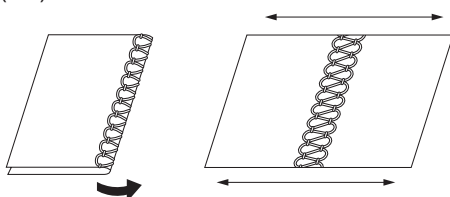

Either stitch finish can be used on the right side of the fabric. If you sew with the wrong sides together, the upper looper thread will decorate the right side when pulled flat. If you sew with the right sides together, the needle thread ladder will decorate the right side when pulled flat.

## NOTE:

*This method is not suitable for thin fabrics.*

## Pin tuck stitching

The Pin tuck stitch uses a rolled edge to add shape and decoration to any sewing project. Contrasting thread in the upper looper adds an accent to your project.

For thin fabrics, it's a good idea to choose a fine thread which will run smoothly.

## Procedure

1. Attach the blind stitch foot (see "CHAPTER 1 Removing/Attaching the presser foot").
2. Set up the machine for narrow overlock stitching. (See "CHAPTER 5 Narrow overlock / Rolled hemming stitch".)
3. Draw equally spaced lines on the fabric with a fabric pencil as guides for pin tuck placement. Fold the fabric along one of the lines and press in place lightly with an iron.

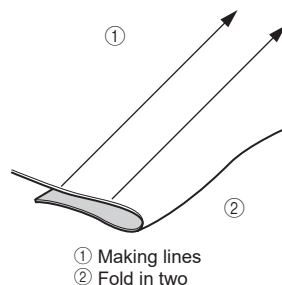

4. Turn the handwheel so that the mark on the handwheel is aligned to the line on the machine (see "CHAPTER 1 Turning direction of the handwheel").
5. Lift the presser foot lifting lever and insert the fabric with the folded edge in such a way that the needle pierces just the folded edge.
6. Lower the presser foot lifting lever, adjust the fabric guide toward the folded edge.
7. Align the blind stitch foot fabric guide with the line on the right side of the stitch finger. By turning the screw forward (toward you), the fabric guide will go to the right. By turning the screw backward (away from you), the fabric guide will go to the left.

8. Align the fold with the fabric guide and insert the fabric up to the needle position.

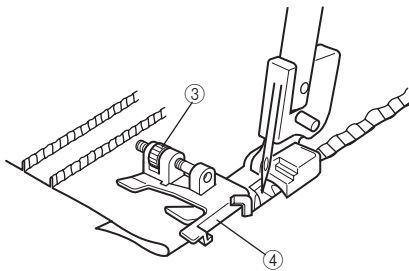

- ③ Adjusting screw  
④ Fabric guide

9. Guide the fold in the fabric to sew half way between the needle and the upper knife.  
10. Continue sewing until all marked lines have been sewn.

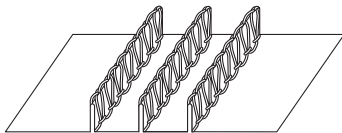

Correct minor contractions by hand.

## Taping (Elastic) foot

### Features

By using the taping (elastic) foot, you can sew tapes, as well as elastics and hem at the same time beautifully.

- Tapes or elastics from 6 mm (15/64 inch) up to 12 mm (15/32 inch) width can be sewn.
- Attaching tapes is very useful for reinforcement on stretchable materials such as knitted garment at shoulder. Also attaching elastics is suitable for sewing cuffs, necklines, etc.

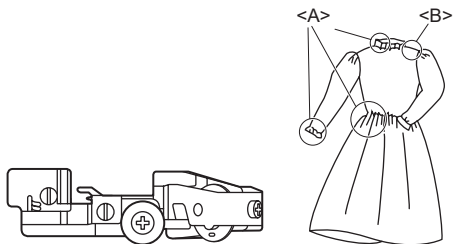

- <A> Usage of the elastic  
<B> Usage of the tape

### Machine setting (type of stitch):

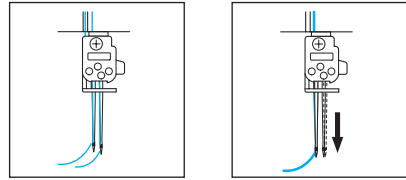

- Two needle 4 thread overlock stitch
- One needle 3 thread overlock stitch (Either needle can be used.)

### How to set the tape/elastic

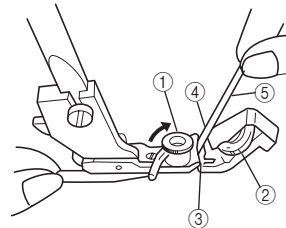

1. Attach the taping (elastic) foot (see "CHAPTER 1 Removing/Attaching the presser foot").
2. Lift the presser foot lifting lever.
3. Turn the handwheel so that the mark on the handwheel is aligned to the line on the machine (see "CHAPTER 1 Turning direction of the handwheel").
4. Flip open the tape guide ①, then set the presser adjusting dial ② at "0".
5. Put the tape or the elastic ⑤ through the slot ③.
6. Insert the tape or the elastic ⑤ through the slot ③ so that the righthand side of tapes/elastics will be set along the guide ④.
7. Flip shut the tape guide ① so that it will be set at the lefthand side of tapes/elastics.

### Test-sewing

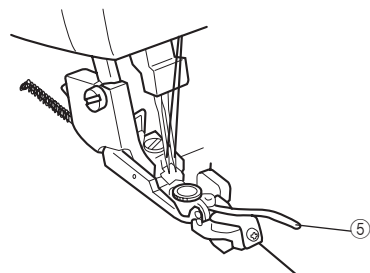

1. Lift the presser foot lifting lever.
2. Insert the materials, till the edge of the materials will touch the upper knife.
3. Lower the presser foot lifting lever.
4. Set the stitch width adjustment dial at "5".

5. Set the stitch length adjustment dial.
  - Tapes: between "3" and "4"
  - Elastics: "4"
6. Adjust the presser adjusting dial ②
  - at "0" when sewing with tapes.
  - at desirable number for contraction when sewing with elastics.

**NOTE:**

*Contraction will be increased with larger number.*

7. Make test-sewing and adjust thread tensions. Example of proper sewing seam:

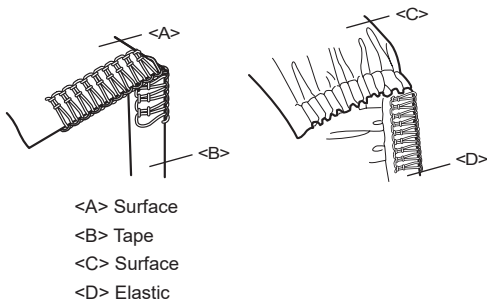

**NOTE:**

*Thread tensions are similar to normal overedging when sewing with tapes. It is recommendable to have stronger tensions for the lower looper and the upper looper for beautiful finish. It is advisable to make trial sewing on each material/thread due to different contraction.*

## Pearl sequence foot

### Features

By using the pearl sequence foot, you can bead on fabric. It is useful for decorated edge of curtains, table clothes, dresses, etc. From 3 mm to 5 mm (1/8 to 13/64 inch) sequins and pearls can be sewn with this foot.

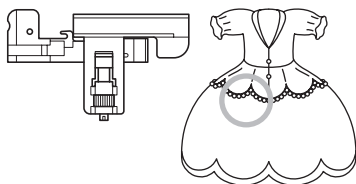

### Preparation

1. Lock the upper knife (see "CHAPTER 1 Locking/Unlocking the upper knife").
2. Attach the pearl sequence foot (see "CHAPTER 1 Removing/Attaching the presser foot").
3. Set up the machine for 3-thread overlock stitch with one needle in the left position. The right needle should be removed.

### How to adjust the machine

1. Adjust the stitch length according to the length as <A> or <B>. For example, 4 mm stitch length means 4 mm for <A> or <B>.

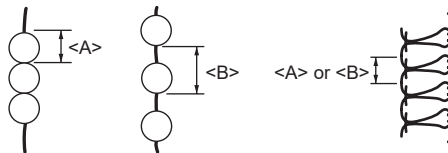

2. Adjust stitch width 3 to 5 mm.
3. Adjust thread tensions as follows:
  - Left needle thread: slightly decrease
  - Upper looper thread: slightly decrease
  - Lower looper thread: slightly increase

### How to set fabric and pearl

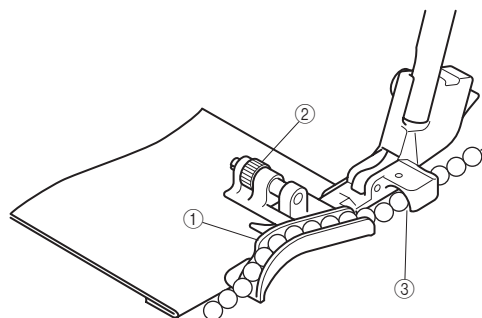
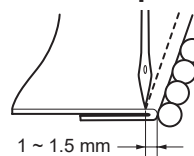

1. Fold the fabric according to the line for pearl fitting.
2. Place the fabric at needle dropping point keeping the folded edge with guide ①.
3. Use the screw ② and adjust the clearance between folded edge needle so that it becomes 1 mm to 1.5 mm (3/64 to 1/16 inch).
4. Place the pearl through the guide just front of guide tunnel ③.

### Test-sewing

1. Sew turning handwheel by hand until the pearl comes through the tunnel.
2. Sew at slow speed while guiding the strand of pearls and fabric by hand.
3. Tie both ends of thread at the beginning and the end.

**NOTE:**

*Thread tension is easy to loosen especially for small size pearls. Lower movable stitch finger for better stitching.*

## Piping foot

### Features

By using the piping foot, you can attach piping at the edge of material. Piping is used to decorate the edge of fabric (pajamas, sports ware), cover for furniture, cushion, bag, etc.

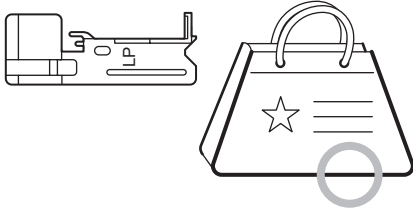

### Preparation

Attach the piping foot (see "CHAPTER 1 Removing/Attaching the presser foot").

### Machine setting (type of stitch):

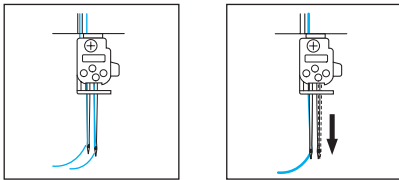

- Two needle 4 thread overlock stitch
- One needle 3 thread overlock stitch (the right needle should be removed)

### How to adjust the machine

1. Set stitch length at 3 mm (1/8 inch). (standard position)
2. Set stitch width at 5 to 6 mm (13/64 to 15/64 inch)
3. Adjust thread tensions for ordinary overlock stitching (see "CHAPTER 5 Stitch selection").

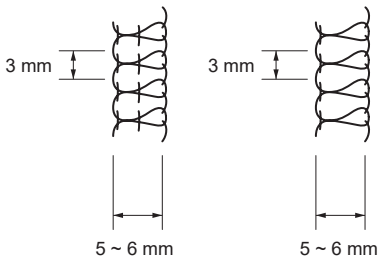

## How to set fabric and piping tape

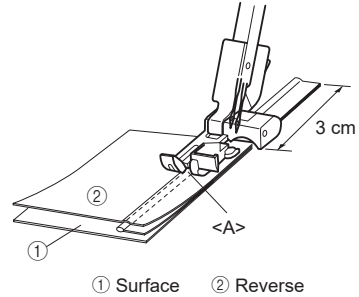

1. Put piping tape between the 2 pcs of fabric and adjust both edges of the fabric as illustrated. Keep 3cm (1 3/16 inch) piping tape over the edge of fabric for steady sewing. (The surface of fabric should be inside.)
2. Place fabric with piping tape under the presser foot, put the piping tape into the groove <A> of the piping foot, and start sewing.

### Start sewing

1. Carefully guide the fabric and the piping tape by hands during sewing.
2. Turn both sides of the fabric after sewing.

#### NOTE:

*For easy sewing, baste the both fabric and piping tape before sewing.*

*Piping sewing is difficult at sharp angles.*

*In case of wide piping tape, the tape should be attached after trimming the excess tape.*

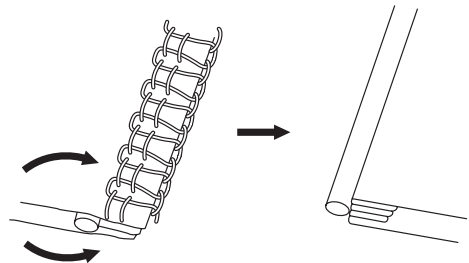

## Gathering foot

### Features

You can create beautiful gathers using the gathering foot on various garment and home decorating applications.

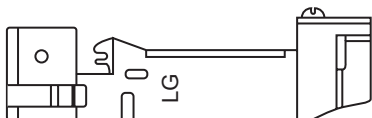

### Preparation

Attach the gathering foot (see "CHAPTER 1 Removing/Attaching the presser foot").

### Machine setting (type of stitch):

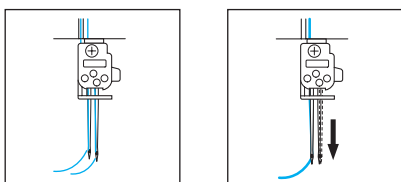

- Two needle 4 thread overlock stitch
- One needle 3 thread overlock stitch (Either needle can be used.)

### How to set fabric

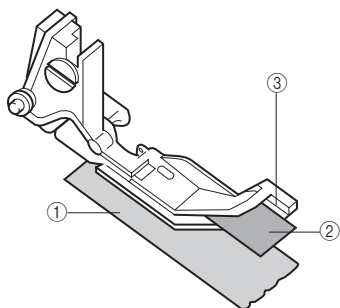

① Surface ② Reverse ③ Guide

1. Raise the presser foot lifting lever.
2. Turn the handwheel so that the mark on the handwheel is aligned to the line on the machine (see "CHAPTER 1 Turning direction of the handwheel").
3. Position the bottom piece of fabric (the fabric that will be gathered ① under the guide ③ just below the needle).
4. Position the top piece of fabric ② between the gathering foot and the guide ③ on top of the bottom fabric ①.
5. Lower the presser foot lifting lever.

### Test-sewing

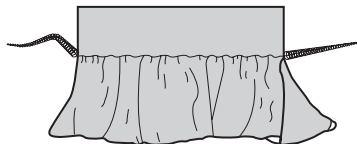

1. Set the stitch length to 3 mm.
2. Set the differential feed ratio to 2.
3. Set the stitch width to 5 mm.
4. Adjust the other settings to those used during default overlock sewing.
5. Sew while keeping the fabric aligned with the guide ③.
  - Adjust the size of the gathers by setting the stitch length between 2 mm and 5 mm.
  - Adjust the amount of fabric that is gathered by setting the differential feed ratio between 1.0 and 2.0.

#### NOTE:

*Do not pull or stretch the fabric during sewing.*

# SPECIFICATIONS

## Specifications

### Use

Fine to heavy materials

### Sewing speed

Maximum 1,300 stitches per minute

### Stitch width

2.8 mm to 7.5 mm (7/64 to 19/64 inch)

### Stitch length (pitch)

2 mm to 4 mm (5/64 to 5/32 inch)

### Needle bar stroke

26.4 mm (1 3/64 inch)

### Presser foot

Free presser type

### Presser foot lift

5 mm to 6 mm (3/16 to 15/64 inch)

### Needle

130/705H

### Number of needles and threads

Two needles or single needle

Two/three/four threads convertible

### Machine net weight

9.8 kgs.

### Machine dimensions

370 mm (W) x 405 mm (H) x 355 mm (D)

(Approx. 14-9/16 (W) x 15-15/16 (H) x  
13-31/32 (D) inches)



Various optional accessories are available to be purchased separately.  
Visit our website <https://s.brother/cotkb/>.



Please visit us at <https://s.brother/cptab/> where you can get the support information (Instruction Videos, FAQs, etc.) for your Brother product.



Brother SupportCenter is a mobile app that provides the support information for your Brother product.  
Visit the Google Play™ or App Store to download.



Google Play™



App Store

This machine is approved for use in the country of purchase only. Local Brother companies or their dealers will only support machines purchased in their own countries.

English  
884-B20/B21



XB4364-001